



Thank you for purchasing a Honda Outboard Motor.

This manual covers operation and maintenance of the Honda BF8D/BF10D/BF15D/BF20D Outboard Motor.

All information in this publication is based on the latest product information available at the time of approval for printing.

Honda Motor Co., Ltd. reserves the right to make changes at any time without notice and without incurring any obligation.

No part of this publication may be reproduced without written permission.

This manual should be considered a permanent part of the Outboard Motor and should remain with it if it is resold.

Throughout this manual, you will see safety messages preceded by the following words and symbols. Here's what they mean:

▲ DANGER

Indicates serious injury or death WILL result if instructions are not followed.

▲ WARNING

Indicates a strong possibility that serious personal injury or death may result if instructions are not followed.

▲ CAUTION

Indicates a possibility that personal injury or equipment damage could result if instructions are not followed.

NOTICE

Indicates that equipment or property damage could result if instructions are not followed.

NOTE: Gives helpful information.

If a problem should arise, or if you have any questions about the Outboard Motor, consult an authorized Honda Outboard Motor dealer.

▲ WARNING

Honda Outboard Motors are designed to give safe and dependable service if operated according to instructions. Read and understand the Owner's Manual before operating the Outboard Motor. Failure to do so could result in personal injury or equipment damage.

- The illustration may vary according to the type.

Honda Motor Co., Ltd. 2011,
All Rights Reserved

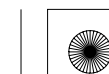



Model Type	BF10D						
	SHU SHD	LHU LHD	SHSU SHSD	LHSU LHSD	SRU	LRU LRD	XRU
Shaft Length	S	L	S	L	S	L	X
Tiller Handle	H	H	H	H			
Remote Control					R	R	R
Electric starter			S	S	S	S	S
Power Thrust Propeller							
Tachometer					*	*	*
Battery charging DC receptacle	●	●					

NOTE: Note that the types of the outboard motor differ according to the countries where they are sold.



BF10D is provided with the following types according to the shaft length, control system, and start system.

- According to Shaft Length
S: Short Shaft
L: Long Shaft
X: Ultra Long Shaft
- According to Control System
H: Tiller Handle Control
R: Remote Control
*: Optional Equipment

TYPE CODE (Example)

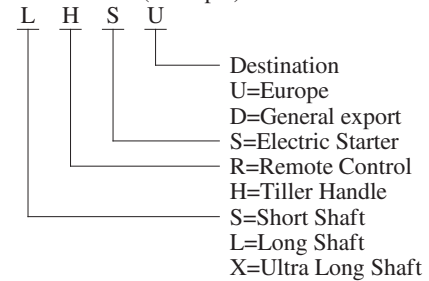



Model Type	BF20D												
	SHU SHD	LHU LHD	SHSU SHSD	LHSU LHSD	SRU SRD	LRU LRD	SHGU SHGD	LHGU LHGD	SHTD	LHTD	SRTU SRTD	LRTU LRTD	XRTD
Shaft Length	S	L	S	L	S	L	S	L	S	L	S	L	X
Tiller Handle	H	H	H	H			H	H	H	H			
Remote Control					R	R					R	R	R
Electric starter			S	S	S	S	S	S	S	S	S	S	S
Gas-assisted Tilt							G	G					
Power Tilt									T	T	T	T	T
Tachometer					*	*					*	*	*
Battery charging DC receptacle	●	●											

NOTE: Note that the types of the outboard motor differ according to the countries where they are sold.



BF20D is provided with the following types according to the shaft length, control system, tilt system, and start system.

- According to Shaft Length
 - S: Short Shaft
 - L: Long Shaft
 - X: Ultra Long Shaft
- According to Control System
 - H: Tiller Handle Control
 - R: Remote Control
- According to tilt system
 - G: Gas-assisted Tilt (with gas damper assist function)
 - T: Power Tilt (with hydraulic assist function)
- *: Optional Equipment

TYPE CODE (Example)

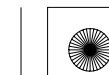
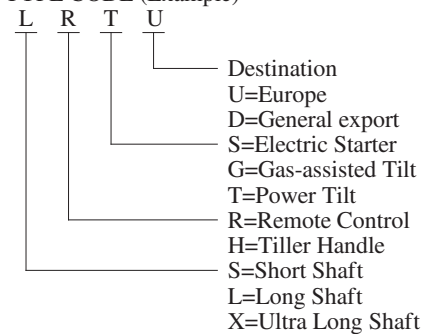



This Owner's Manual is using the following type names when it describes the operations special to a type.

- Tiller handle type: H type
- Remote control type: R type
- Gas-assisted tilt type: G type
- Power tilt type: T type

Check the type of your outboard motor and read this Owner's Manual thoroughly before operation. Texts with no type indication are the information and/or procedures common to all types.

FRAME SERIAL NUMBER

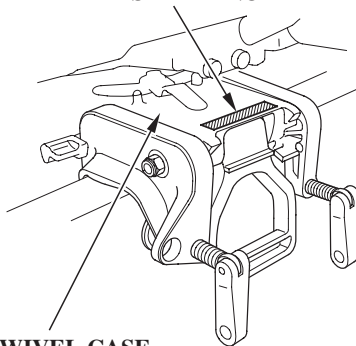

SWIVEL CASE

Record the frame and engine serial numbers for your reference. Refer to the serial numbers when ordering parts, and when making technical or warranty inquiries.

Frame serial number:

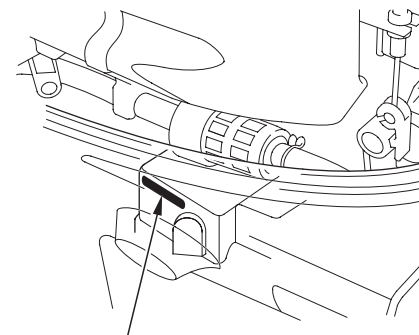

ENGINE SERIAL NUMBER

The frame serial number label is on top of the swivel case. The engine serial number label is on the cylinder block located in the front of the engine.

Engine serial number:

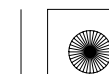



CONTENTS

1. SAFETY.....	10	T type	
SAFETY INFORMATION	10	Power Tilt Switch.....	31
2. SAFETY LABEL LOCATIONS.....	13	Manual Relief Valve.....	32
3. COMPONENT IDENTIFICATION	17	G type	
4. CONTROLS.....	22	Tilt Lever.....	33
H type		Tilt Lock Lever (G and T type).....	34
Starter Grip.....	22	Tilt Lever (Manual tilt type)	34
Engine Start Button.....	22	Anode Metal.....	34
Shift Lever	22	Water Check Hole	35
Choke Knob	23	Cooling Water Intake Port	35
Throttle Grip	23	Engine Cover Latch	36
Throttle Friction Dial	24	Transom Angle Adjusting Rod.....	37
Engine Stop Switch.....	24	Fuel Filler Cap Vent Knob/Fuel Gauge.....	38
Emergency Stop Switch Lanyard	24	Fuel Line Connector.....	39
Oil Pressure Indicator Light.....	25	5. INSTALLATION.....	40
R type		Transom Height.....	40
Remote Control Lever.....	26	Location.....	40
Neutral Release Lever.....	27	Installation Height	41
Engine Switch	27	Outboard Motor Attachment.....	41
Emergency Stop Switch Lanyard	28	Outboard Motor Angle.....	43
Fast Idle Lever.....	29	Battery Connections	46
Oil Pressure Indicator Light/Buzzer	29	Battery Charging DC Receptacle.....	47
Overheat Warning Light/Buzzer.....	30	Remote Control Installation	48
Tachometer (optional equipment).....	30		





CONTENTS

6. PRE-OPERATION CHECKS	49	Tilting the Outboard Motor (Common).....	84
Removing/Installing Engine Cover	49	Manual Tilt type	
Engine Oil Level	50	Tilting the Outboard Motor.....	85
Fuel Level.....	51	G type	
Gasoline Containing Alcohol.....	52	Tilting the Outboard Motor.....	87
Battery Electrolyte Level	53	Moorage	89
Propeller and Cotter Pin.....	54	T type	
Steering Handle Friction (H type).....	55	Tilting the Outboard Motor.....	90
Remote Control Lever Friction (R type).....	55	Manual Relief Valve	91
Other Checks	56	Moorage	92
7. STARTING THE ENGINE	57	Mooring.....	93
Fuel Tank and Vent Knob.....	57	Engine Protection System.....	94
Fuel Line Connection.....	58	Cruising in Shallows	98
H type		High Altitude Operation	98
Starting the Engine.....	60	9. STOPPING THE ENGINE.....	99
R type		H type	
Starting the Engine.....	66	Stopping the Engine.....	99
Emergency Starting.....	71	R type	
Troubleshooting Starting Problems	78	Stopping the Engine.....	101
8. OPERATION	79	10. TRANSPORTING	102
Break-in Procedure	79	Fuel Line Removal.....	102
H type		Transporting	103
Gear Shifting	79	Trailing	106
Steering	80	11. CLEANING AND FLUSHING.....	107
Cruising.....	80	With Water Hose Joint (Optional part).....	107
R type		Without Water Hose Joint.....	108
Gear Shifting	82		
Cruising	83		





CONTENTS

12. MAINTENANCE	109	18. "EC DECLARATION OF CONFORMITY"	
Tool Kit and Spare Parts	110	CONTENT OUTLINE	152
MAINTENANCE SCHEDULE	111	19. INDEX	157
Engine Oil Change	113	20. WIRING DIAGRAM	Inside back cover
Gear Oil Check/Change	115		
Spark Plug Service	116		
Battery Service	118		
Lubrication	120		
Fuel Filter Check/Replacement	121		
Fuel Tank and Tank Filter Cleaning	124		
EMISSION CONTROL SYSTEM			
(for Bodensee-Lake type)	125		
Choke Knob Friction (Manual choke type)	126		
Replacing the Fuse	127		
Propeller Change	127		
Servicing a Submerged Outboard Motor	128		
13. STORAGE	130		
Fuel	130		
Carburetor Draining	131		
Battery Storage	135		
Transport/Storage Position of the Outboard			
Motor	136		
14. DISPOSAL	137		
15. TROUBLESHOOTING	138		
16. SPECIFICATIONS	140		
17. MAJOR Honda DISTRIBUTOR			
ADDRESSES	149		

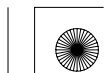



1. SAFETY

SAFETY INFORMATION

For your safety and the safety of others, pay special attention to these precautions.

Operator Responsibility



- **Honda outboard motor is designed to give safe and dependable service if operated according to instructions. Read and understand the Owner's Manual before operating the outboard motor. Failure to do so could result in personal injury or equipment damage.**

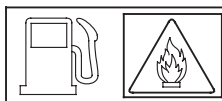

- **Gasoline is harmful or fatal if swallowed. Keep the fuel tank out of reach of children.**
- **Gasoline is extremely flammable and is explosive under certain conditions. Refuel in a well-ventilated area with the engine stopped.**
- **Do not smoke or allow flames or sparks where the engine is refueled or where gasoline is stored.**
- **Do not overfill the fuel tank. After refueling make sure**

that the fuel tank cap is closed properly and securely.

- **Be careful not to spill any fuel while refueling. Spilled fuel or fuel vapor may ignite. If any fuel is spilled make sure that the area is dry before starting the engine.**





SAFETY



Shift to the neutral position and then shift to the reverse position at low engine speed. Do not shift to the reverse position suddenly at high engine speed.



Moving parts can injure you. Install the engine cover after emergency starting the engine. Do not operate the outboard motor without the engine cover.

- Know how to stop the engine quickly in case of emergency. Understand the use of all controls.
- Do not exceed the boat manufacturer's power recommendation, and be sure that the outboard motor is properly mounted.
- Never permit anyone to operate the outboard motor without proper instruction.
- Stop the engine immediately if anyone falls overboard.
- Do not run the engine while the boat is near anyone in the water.
- Attach the emergency stop switch lanyard securely to the operator.
- Before operating the outboard motor, familiarize yourself with all laws and regulations relating to boating and the use of outboard motors.

- Do not attempt to modify the outboard motor.
- Always wear a life-jacket when on board.
- Do not operate the outboard motor without the engine cover. Exposed moving parts can cause injury.
- Do not remove any guards, labels, shields, covers or safety devices; they are installed for your safety.

Fire and Burn Hazards

Gasoline is extremely flammable, and gasoline vapor can explode. Use extreme care when handling gasoline. **KEEP OUT OF REACH OF CHILDREN.**

- Refuel in a well-ventilated area with the engine stopped. Keep flames and sparks away, and do not smoke in the area.





SAFETY

- Refuel carefully to avoid spilling fuel. Avoid overfilling the fuel tank (there should be no fuel in the filler neck). After refueling, tighten the fuel filler cap securely. If any fuel is spilled, make sure the area is dry before starting the engine.

The engine and exhaust system become very hot during operation and remain hot for a while after stopping. Contact with hot engine components can cause burns and may ignite some materials.

- Avoid touching a hot engine or exhaust system.
- Allow the engine to cool before performing maintenance or transporting.

Carbon Monoxide Poisoning Hazard

Exhaust contains poisonous carbon monoxide, a colorless and odorless gas. Breathing exhaust can cause loss of consciousness and may lead to death.

- If you run the engine in an area that is confined, or even partially enclosed, the air can become contaminated with a dangerous amount of exhaust gas. To keep exhaust gas from building up, provide adequate ventilation.

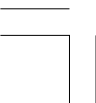



2. SAFETY LABEL LOCATIONS

[Equipped type]

These labels and indications warn you of potential hazards that can cause serious injury. Read the labels, indications and safety notes and precautions described in this manual carefully. If a label comes off or becomes hard to read, contact your Honda outboard motor dealer for a replacement.

**READ OWNER'S MANUAL
GEAR SHIFTING**



**READ OWNER'S
MANUAL**

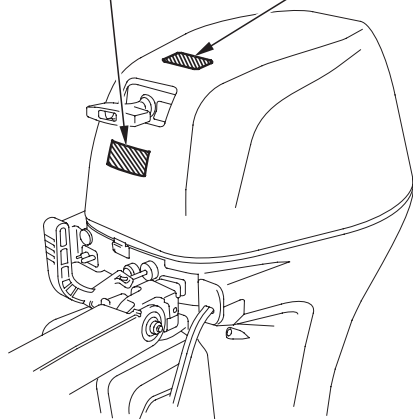

**READ OWNER'S MANUAL
EMERGENCY ENGINE STARTING**

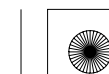
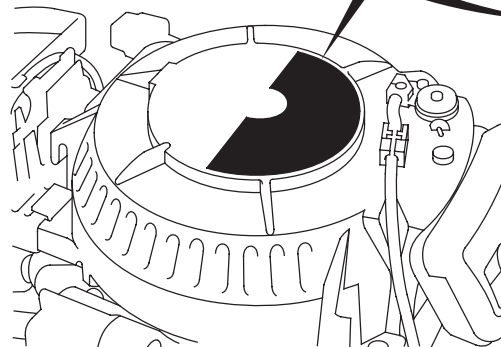
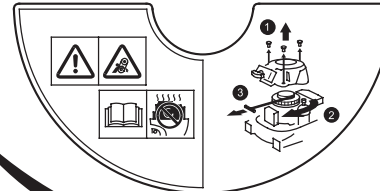



SAFETY LABEL LOCATIONS

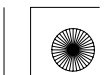
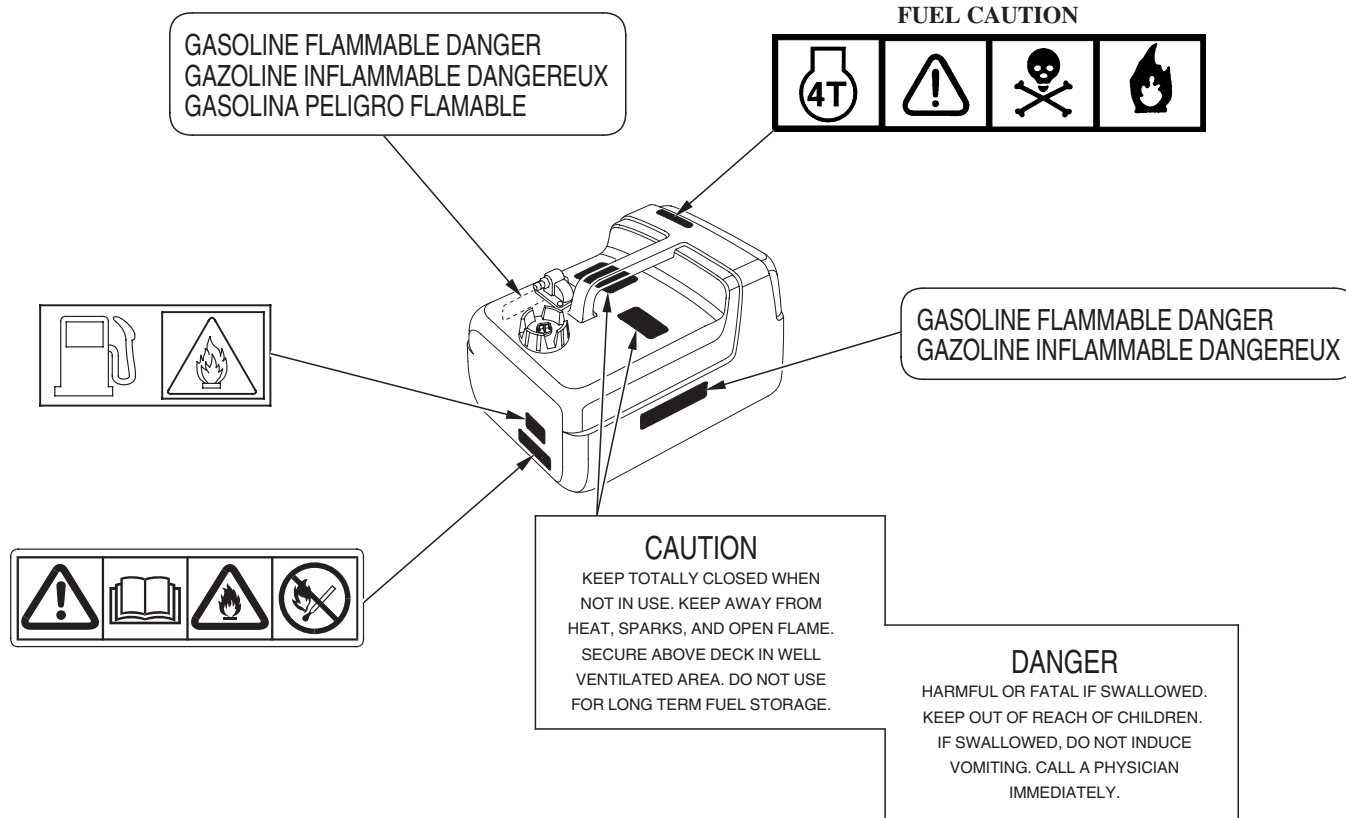



SAFETY LABEL LOCATIONS

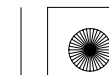
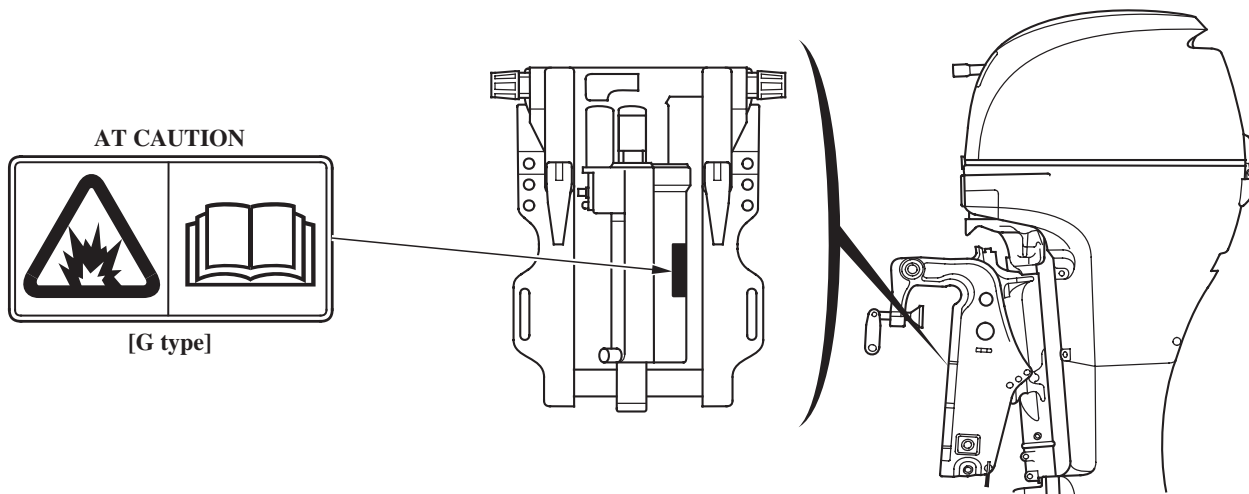



SAFETY LABEL LOCATIONS

CE mark location [U type]

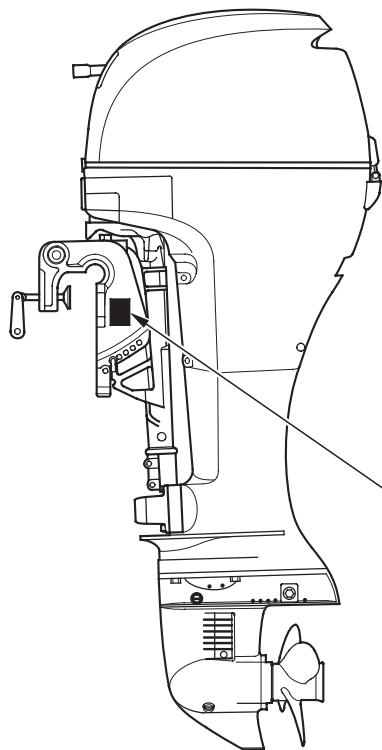

CE MARK

CE	Year of Mfg. []	PG BF 15D (HNX0350G0) ARD4	
Rated power		11.0 kw	
Mass		46.5-61.0 kg	Dry weight (with propeller)
Honda Motor Co., Ltd. 2-1-1 Minamiosoyama, Minato-ku, Tokyo, Japan		Honda Motor Europe Ltd. Aalst Office Wijngaardveld 1 (Noord V), 9300 Aalst - BELGIUM	
Manufacturer and address		Name and address of authorized representative	

[Example: BF15D]

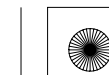



3. COMPONENT IDENTIFICATION

TILLER HANDLE TYPE (H type)

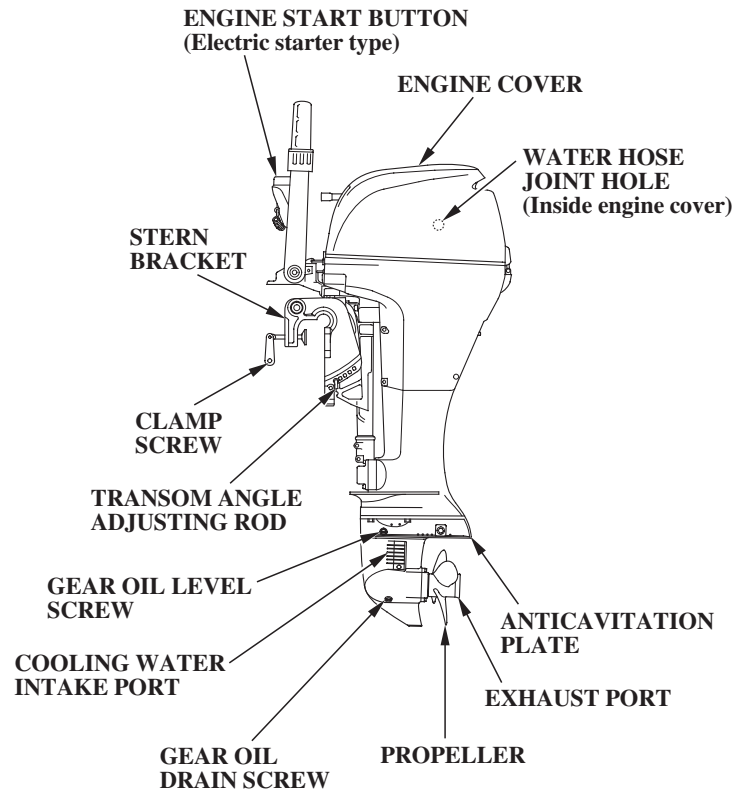
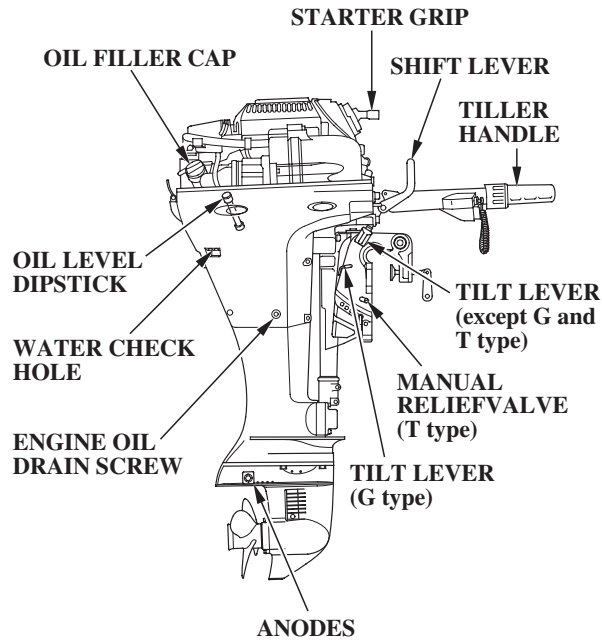



COMPONENT IDENTIFICATION

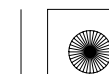
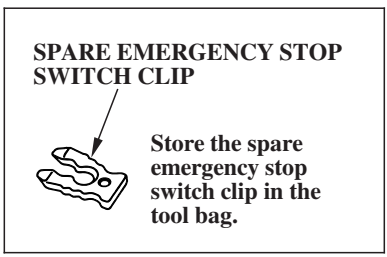
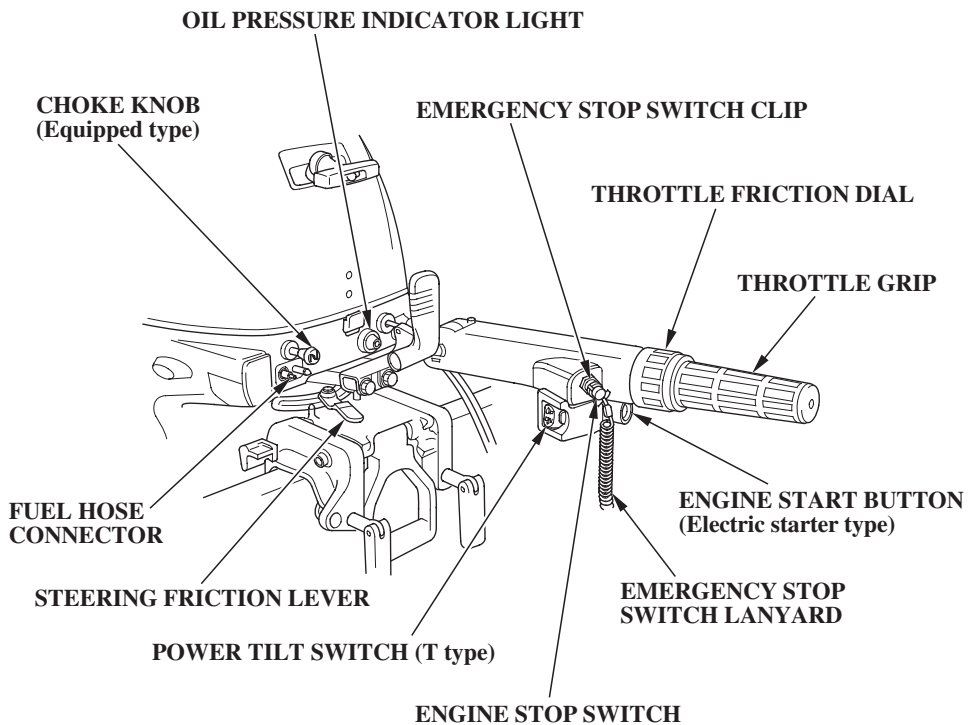



COMPONENT IDENTIFICATION

REMOTE CONTROL TYPE (R type)

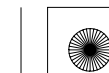
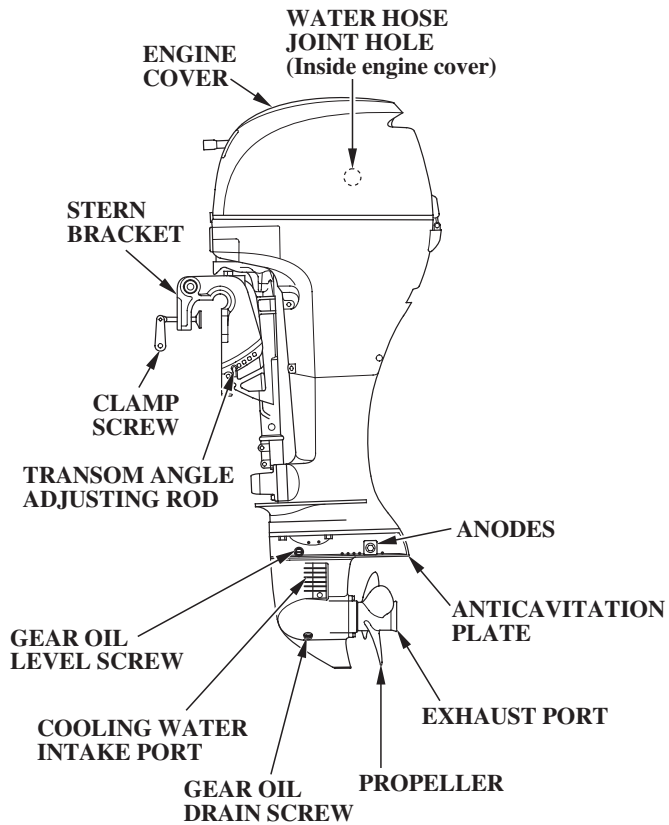
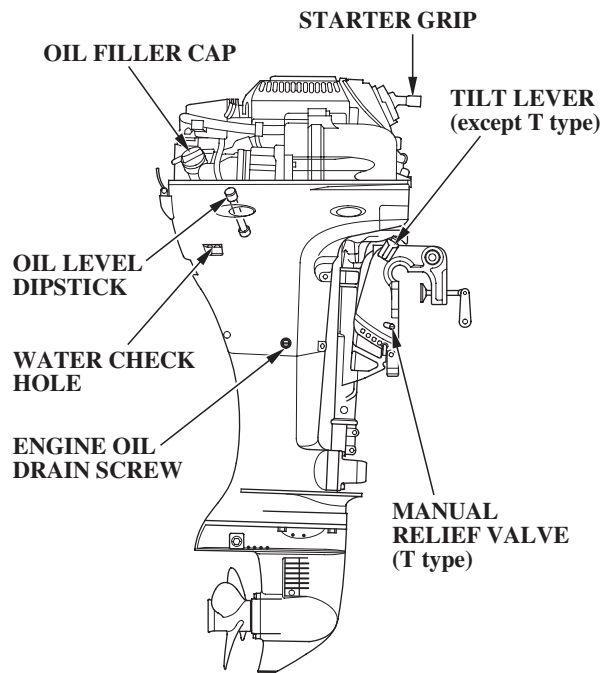



COMPONENT IDENTIFICATION

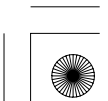
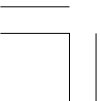
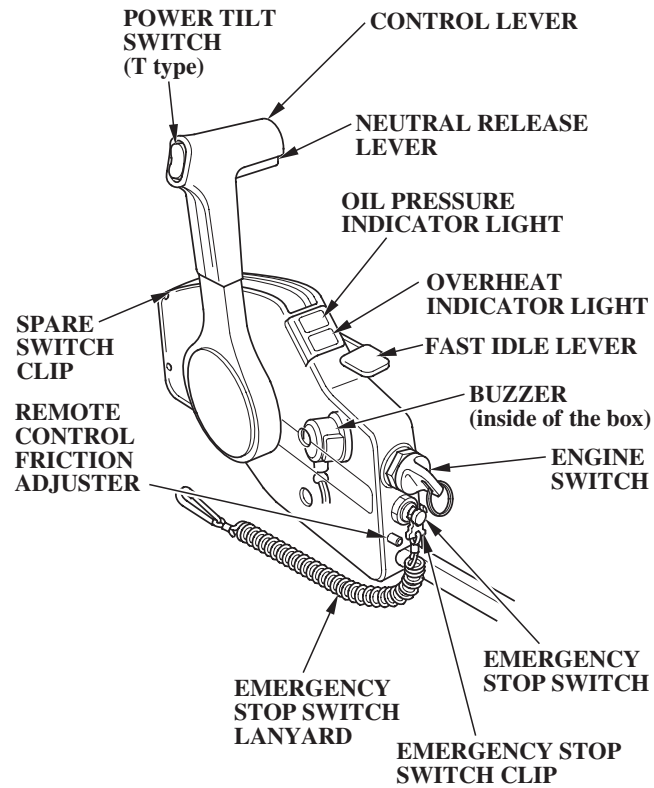



COMPONENT IDENTIFICATION

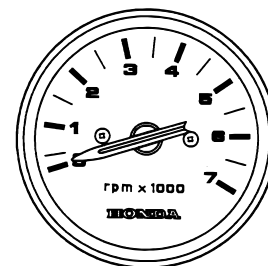
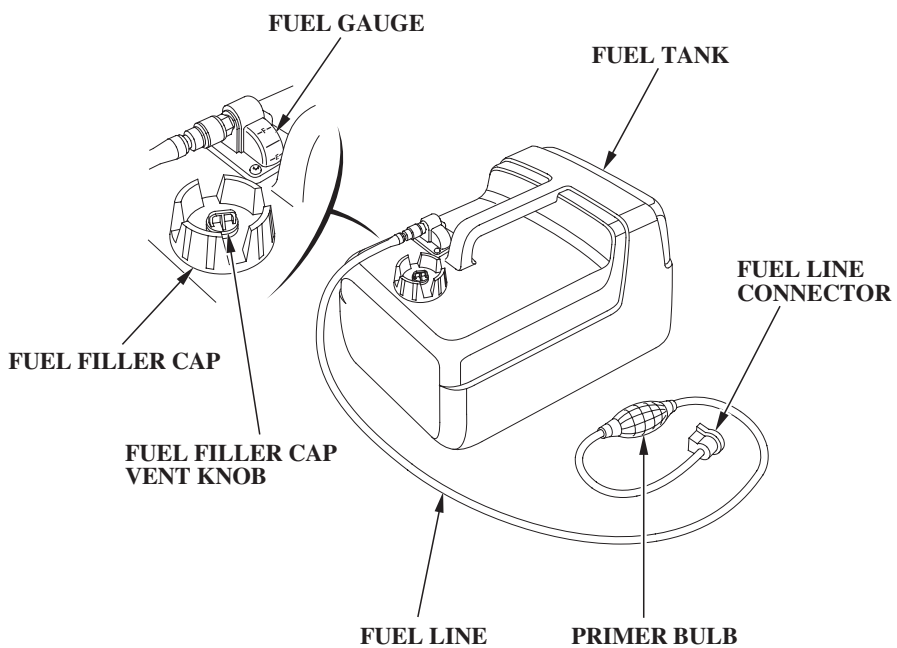

TACHOMETER
[optional equipment (R type)]

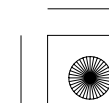
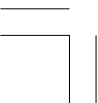



4. CONTROLS (H type)

Starter Grip

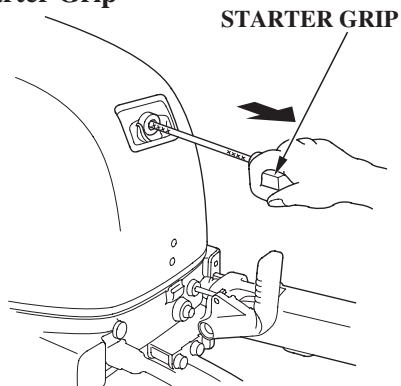

Pulling the starter grip operates the recoil starter to crank the engine for starting. Set the shift lever in the N (neutral) position before starting.

NOTE:

The engine does not start by pulling the starter grip unless the shift lever is in the N (neutral) position.

Engine Start Button (Electric starter type)

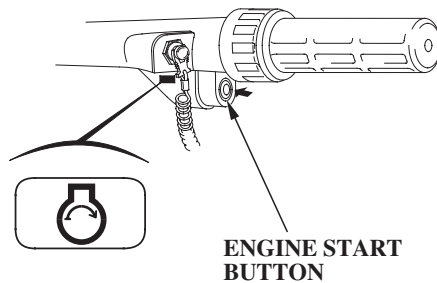

Use the engine start button to start the engine. Set the shift lever in the N (neutral) position before starting.

NOTE:

The engine does not start by pressing the electric starter button unless the shift lever is in the N (neutral) position.

Shift Lever

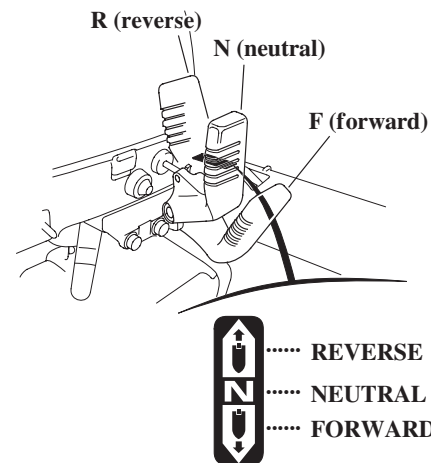

Use the shift lever to run the boat in forward or reverse gear, or to cut off the engine power from the propeller. There are three positions for the shift lever.

FORWARD: The boat moves ahead.

NEUTRAL: The engine power is cut off from the propeller. The boat does not move.

REVERSE: The boat reverses.

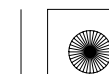



CONTROLS (H type)

Choke Knob (Manual choke type)

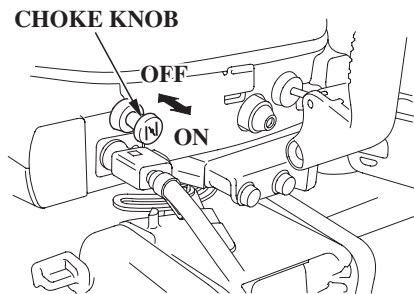

The choke knob opens and closes the choke valve in the carburetor.

The ON position enriches the fuel mixture for starting a cold engine.

The OFF position provides the correct fuel mixture for operation after starting, and for restarting a warm engine.

Throttle Grip

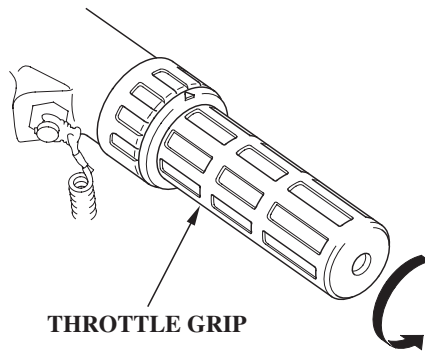

Turn the grip clockwise or counterclockwise to adjust the engine speed. Turning the grip in the direction shown by arrow increases the engine speed.

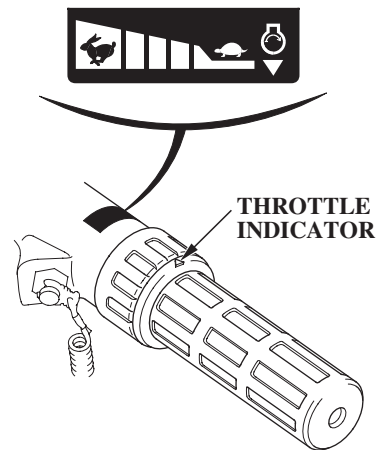

The curve on the grip label indicates the engine speed.

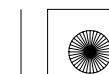



CONTROLS (H type)

Throttle Friction Dial

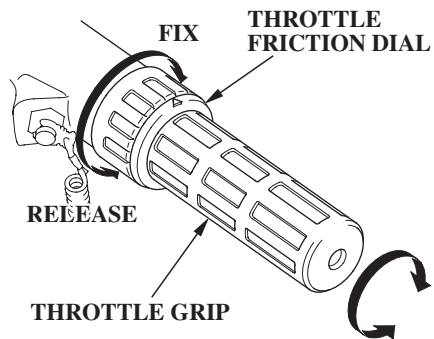

Use the engine throttle fixing dial to cruise at a certain constant speed. Turning the fixing dial clockwise fixes the throttle grip in place, and it is released by turning the fixing dial counterclockwise.

Engine Stop Switch

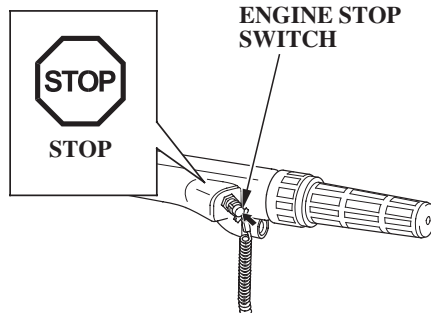

Press the engine stop switch to stop the engine.

Emergency Stop Switch Lanyard

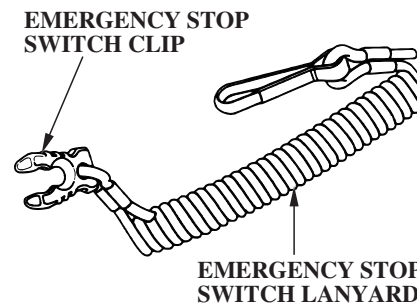

The emergency stop switch lanyard is provided to stop the engine immediately when the operator falls overboard or away from the outboard motor.

The engine stops when the clip at the end of the emergency stop switch lanyard is pulled out of the emergency stop switch. When operating the outboard motor, be sure to attach one end of the emergency stop switch lanyard securely to the operator.

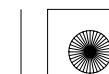



CONTROLS (H type)

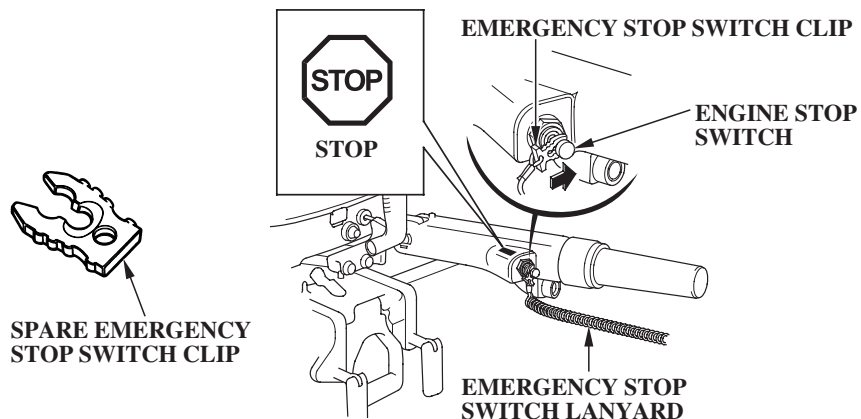

▲ WARNING

If the emergency stop switch lanyard is not set, the boat might run out of control when the operator, for example, falls overboard and is not able to operate the outboard motor.

For the sake of the operator's and the passengers' safety, be sure to set the emergency stop switch clip located at one end of the emergency stop switch lanyard with the emergency stop switch. Attach the other end of

the emergency stop switch lanyard securely to the operator.

NOTE:

The engine does not start unless the emergency stop switch clip is set on the engine stop switch. Store the spare emergency stop switch clip in the tool bag.

Oil Pressure Indicator Light

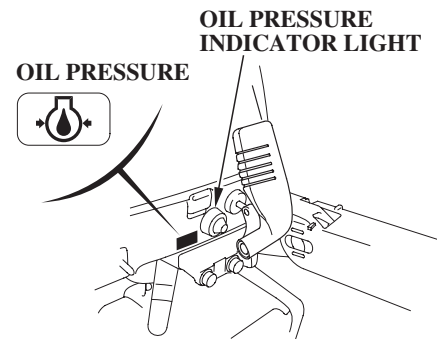

When the engine oil level is low or the engine lubrication system is faulty, the oil pressure indicator light turns off.

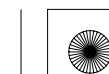



CONTROLS (R type)

Remote Control Lever

REMOTE CONTROL LEVER

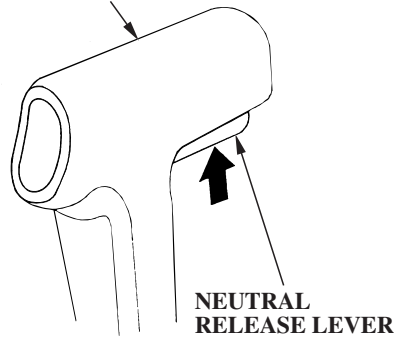

Shifting gear into forward, reverse, or neutral and the engine speed adjustment can be performed with the remote control lever. Push up the neutral release lever before operating the remote control lever.

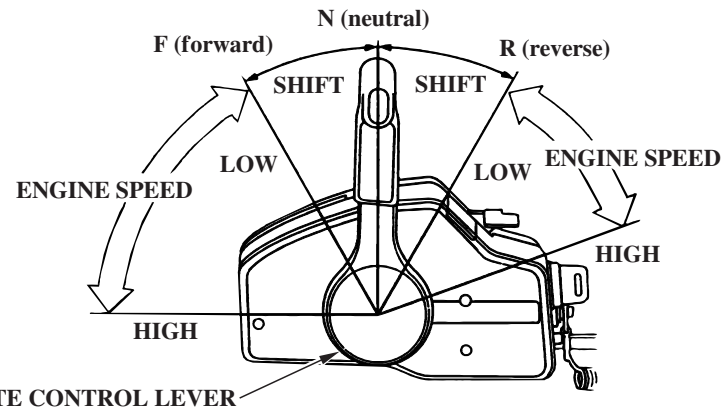

FORWARD:

Moving the lever to the FORWARD position (i.e. approximately 30° from the NEUTRAL position) engages the gear into forward. Moving the lever further from the FORWARD position will increase the throttle opening and the boat forward speed.

NEUTRAL:

Engine power is cut off from the propeller.

REVERSE:

Moving the lever to the REVERSE position (i.e. approximately 30° from the NEUTRAL position) engages the gear into reverse. Moving the lever further from the REVERSE position will increase the throttle opening and the boat reverse speed.

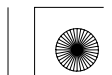



CONTROLS (R type)

Neutral Release Lever

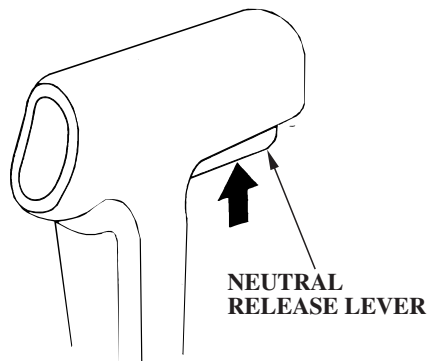

The neutral release lever is set on the remote control lever to prevent an accidental operation of the remote control lever.

The remote control lever does not operate unless it is moved while pushing the neutral release lever up.

Engine Switch

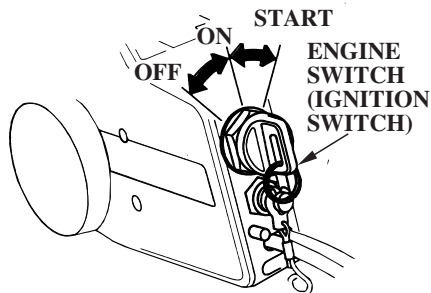

This remote control is equipped with an automotive type ignition switch.

Key positions:

- START: to start the engine.
- ON: to run the engine after starting.
- OFF: to stop the engine (IGNITION OFF).

NOTICE

Do not leave the engine switch (ignition switch) ON (key in ON position) when the engine is not running as the battery will discharge.

NOTE:

The starter motor will not work unless the remote control lever is in the N (neutral) position.

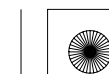



CONTROLS (R type)

Emergency Stop Switch Lanyard

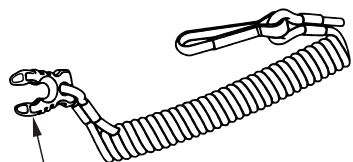

EMERGENCY STOP SWITCH CLIP

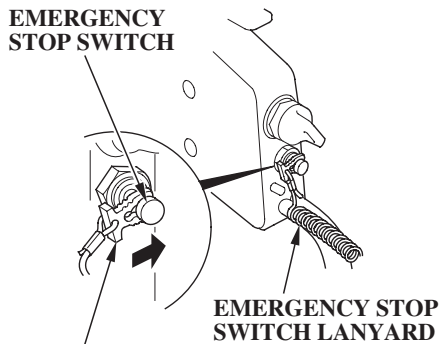

EMERGENCY STOP SWITCH CLIP

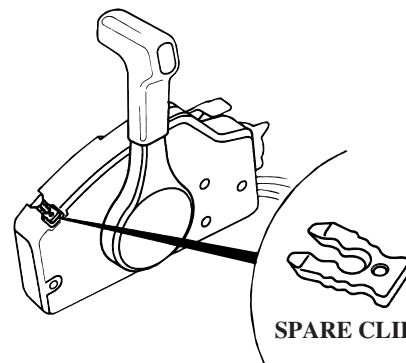

SPARE CLIP

The emergency stop switch lanyard is provided to stop the engine immediately when the operator falls overboard or away from the outboard motor.

The engine stops when the clip at the end of the emergency stop switch lanyard is pulled out of the emergency stop switch. When operating the outboard motor, be sure to attach one end of the emergency stop switch lanyard securely to the operator.

▲ WARNING

If the emergency stop switch lanyard is not set, the boat might run out of control when the operator, for example, falls overboard and is not able to operate the outboard motor.

For the sake of the operator's and the passengers' safety, be sure to set the emergency stop switch clip and attach one end of the emergency stop switch lanyard securely to the operator.

NOTE:

The engine does not start unless the emergency stop switch clip is set on the emergency stop switch.

A spare emergency stop switch clip is provided on the remote control box.

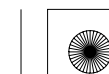



CONTROLS (R type)

Fast Idle Lever

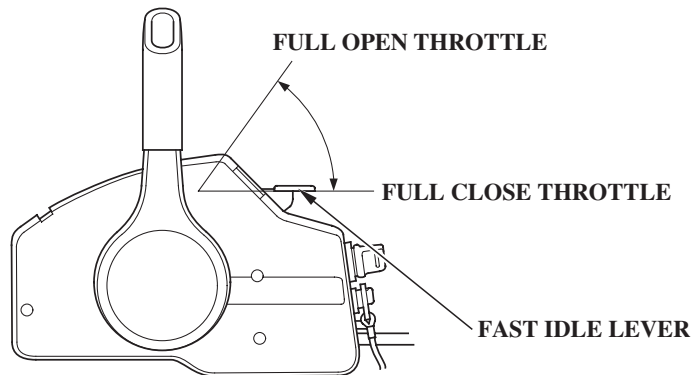

The fast idle lever is provided with the engine speed adjustment function. The lever does not move unless the remote control lever is in the "N" (neutral) position. Note also that the control lever does not move unless the fast idle lever is in the "full close" position.

Use the fast idle lever for engine warm-up after starting a cold engine and when starting a warm engine.

Oil Pressure Indicator Light/ Buzzer

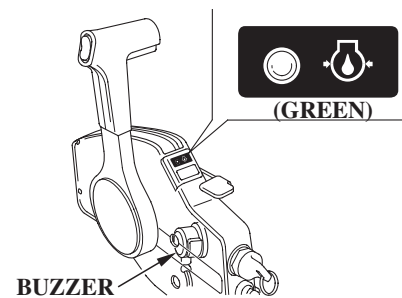

The oil pressure indicator light turns off and the buzzer sounds when the oil level is low and/or the engine lubrication system is faulty.

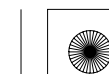



CONTROLS (R type)

Overheat Warning Light/Buzzer

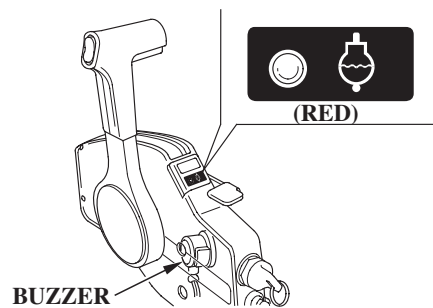

The overheat warning light turns on and the buzzer sounds when the engine cooling circuit is faulty. The engine speed slows down this time.

Tachometer (optional equipment)

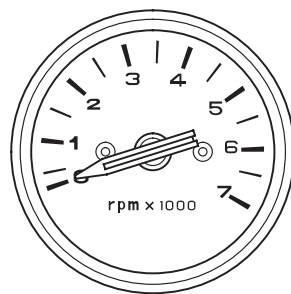

The tachometer shows the engine speed in revolutions per minute.

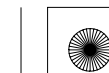



CONTROLS (T type)

Power Tilt Switch

Press the power tilt switch on the control lever (R type) or tiller handle (H type), and the outboard motor installation angle (tilt angle) can be adjusted only while stopping the boat.

Power tilt is a convenience for tilting the outboard motor, shallow water operation, and trailering only. It is not designed to be used as a trim function to adjust the trim angle of the boat.

During shallow water operation, beaching, launching, or mooring, proceed at low speed with a small throttle opening and tilt the outboard motor up as necessary (see page 98).

(H type)

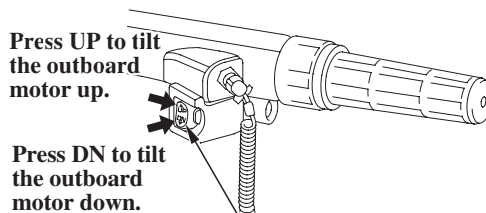

POWER TILT SWITCH

(R type)

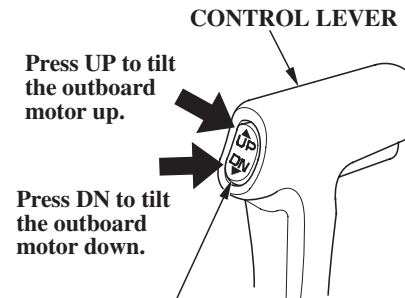

POWER TILT SWITCH

Excessive trim angle can result in cavitation and racing of the propeller, and tilting up the outboard motor excessively can cause damage to the impeller pump.





CONTROLS (T type)

Manual Relief Valve

If the power tilt switch does not operate because of, for example, dead battery, the outboard motor can be tilted manually by opening the manual relief valve.

To move the outboard motor by hand, turn the manual relief valve under the stern bracket 2 and a half turns counterclockwise using a screw driver.

After moving the outboard motor, turn the screw clockwise securely.

▲WARNING

Be sure to tighten the manual relief valve securely. The outboard motor could rise when sailing in the reverse gear, resulting in an accidental injury to the passenger(s).

NOTICE

Do not loosen the manual relief valve more than three turns, or the outboard motor cannot be tilted up when the manual relief valve is retightened.

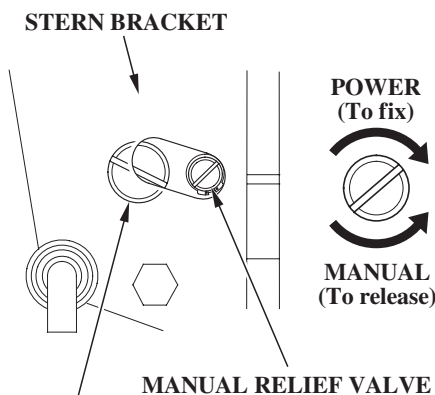

▲WARNING

Never loosen this screw. Hydraulic oil of the power tilt system flows out.

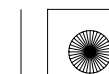



CONTROLS (G type)

Tilt Lever

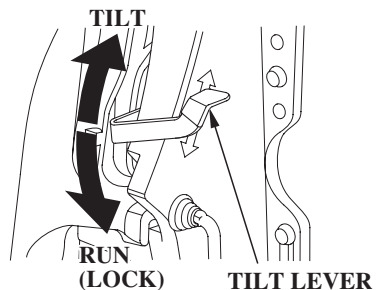

Use the tilt lever to temporarily raise the outboard motor when the boat is sailing in the shallows, or mooring or anchoring in the shallows. Raising the tilt lever unlocks the outboard motor and the outboard motor can be tilted. Lowering the tilt lever locks the outboard motor.

▲WARNING

Be sure to lower the tilt lever and lock the outboard motor before sailing. The outboard motor could rise when sailing in the reverse gear, resulting in an accidental injury to the passenger(s).

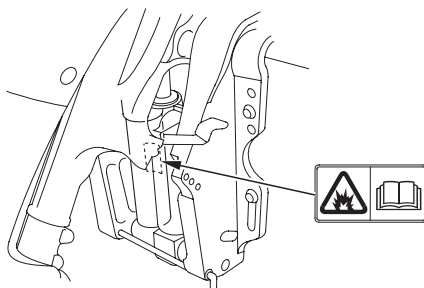

▲WARNING

Do not disassemble the gas assisted damper assembly as it is filled with the high pressure gas.

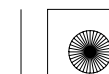



CONTROLS

Tilt Lock Lever (G and T type)

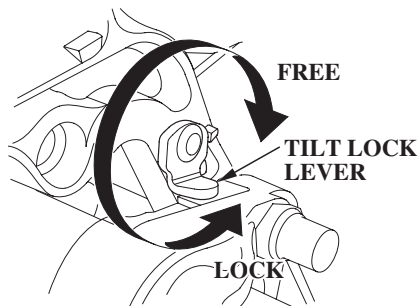

Use the tilt lock lever to raise the outboard motor and lock it in the position when the boat is moored or anchored for a long time. Tilt the outboard motor as far as it goes and move the lock lever in the locking direction.

Tilt Lever (Manual tilt type)

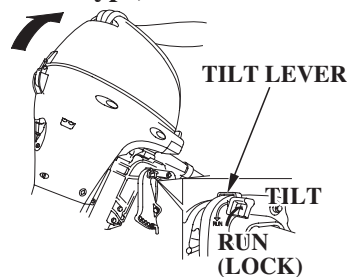

Use the tilt lever to temporarily raise the outboard motor when the boat is sailing in the shallows, or mooring or anchoring in the shallows. Raising the tilt lever unlocks the outboard motor and the outboard motor can be tilted. Lowering the tilt lever locks the outboard motor.

▲WARNING

Be sure to lower the tilt lever and lock the outboard motor before sailing. The outboard motor could rise when sailing in the reverse gear, resulting in an accidental injury to the passenger(s).

Anode Metal

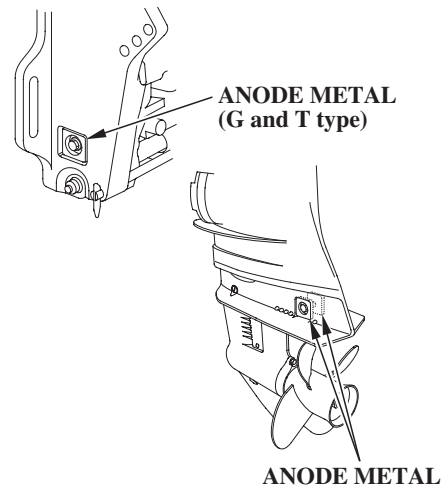

The anode metal is a sacrificed metal which protects the outboard motor from corrosion.

NOTICE

Do not paint the anode metal. It deteriorates the function of the anode metal, which can lead to rust and corrosion damage to the outboard motor.

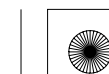



CONTROLS

Water Check Hole

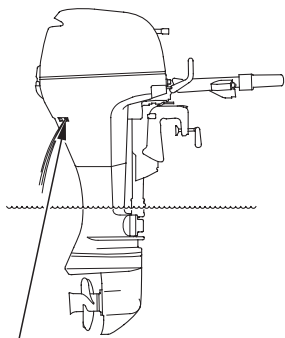

WATER CHECK HOLE

The cooling water is checked here to see whether it is circulating inside the engine properly.

After starting the engine, check at the cooling water check hole whether the cooling water is circulating through the engine.

Cooling Water Intake Port

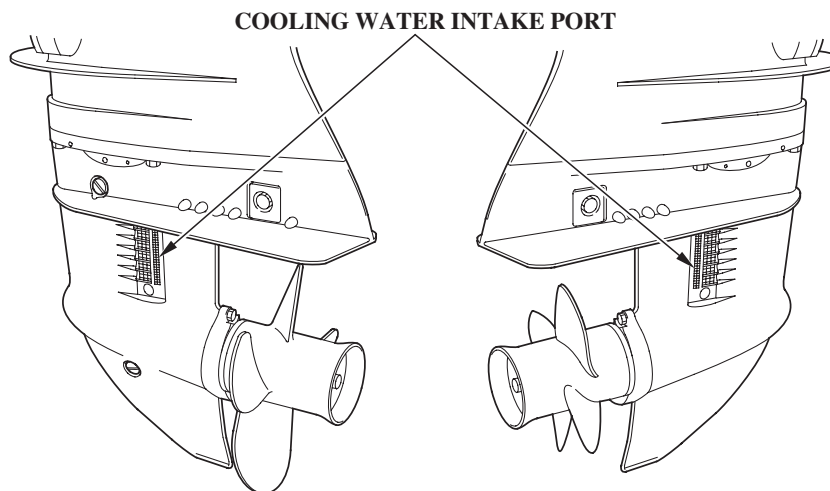

The engine cooling water is drawn into the engine through this port.

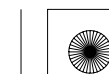



CONTROLS

Engine Cover Latch

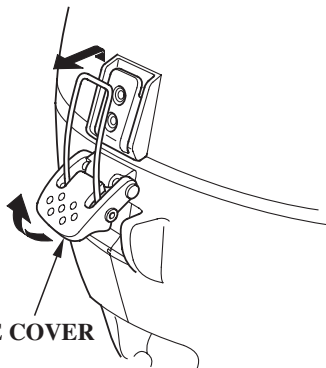

**ENGINE COVER
LATCH**

Latch/unlatch the engine cover latch to install or remove the engine cover.

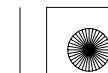
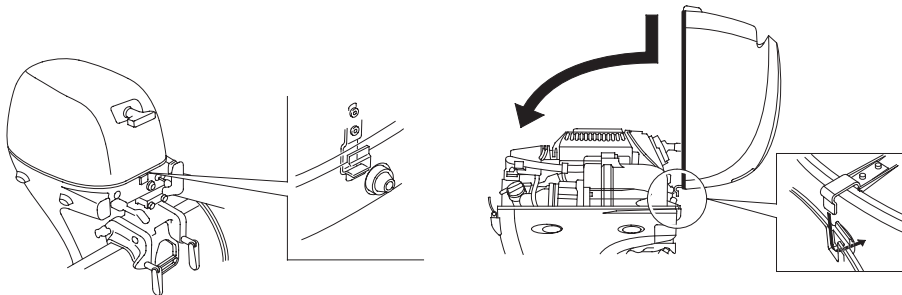



CONTROLS

Transom Angle Adjusting Rod (Manual tilt type)

- BF8D/BF10D
(SH type/LH type)

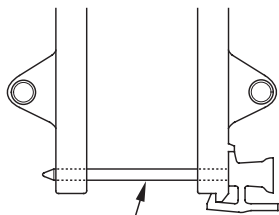

**TRANSOM ANGLE
ADJUSTING ROD**

- BF8D
(R type)
- BF10D
(XH type/R type)
- BF15D/BF20D

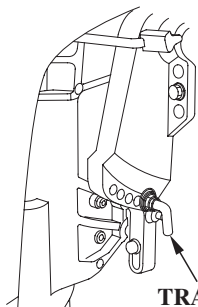

**TRANSOM ANGLE
ADJUSTING ROD**

(G and T type)

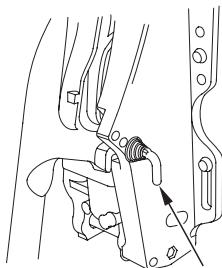

**TRANSOM ANGLE
ADJUSTING ROD**

Use the transom angle adjusting rod to adjust the outboard motor angle properly.

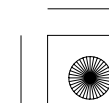
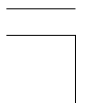



CONTROLS

Fuel Filler Cap Vent Knob/Fuel Gauge

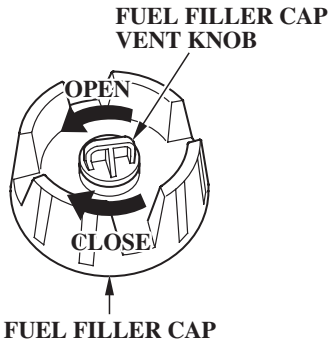

The vent knob shuts off the fuel tank from the open air. When refilling the fuel tank, turn the vent knob counterclockwise to open and remove the fuel filler cap. Turn the vent knob clockwise and close it securely before transporting or storing the outboard motor.

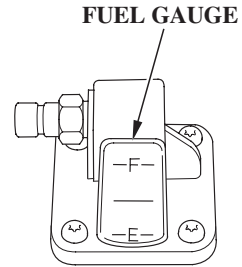

The fuel gauge indicates the fuel level in the tank.

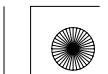



CONTROLS

Fuel Line Connector

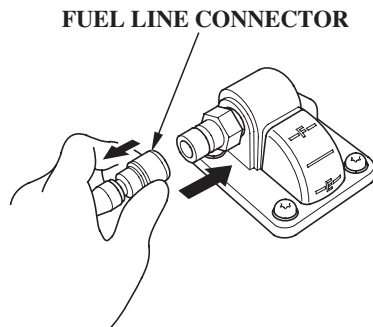

FUEL LINE CONNECTOR

(FUEL TANK SIDE)

The fuel line connector is used to connect the fuel line between the separate fuel tank and the outboard motor.

FUEL LINE CONNECTOR

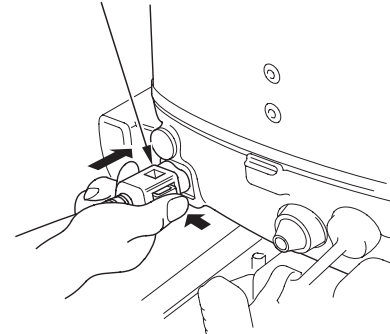

(OUTBOARD MOTOR SIDE)

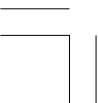



5. INSTALLATION

NOTICE

Improperly installed outboard motor can result in the outboard motor dropped into the water, boat not able to cruise straight ahead, engine speed not increase, and much fuel consumption.

We recommend that the outboard motor be installed by an authorized Honda outboard motor dealer. Consult the authorized Honda dealer in your area for the Y-OP (User Optional Parts)/equipments installation and operation.

Applicable Boat

Select the boat suitable for the engine power.

Engine power:

BF8D: 5.9 kW (8.0 PS)

BF10D: 7.4 kW (10 PS)

BF15D: 11.0 kW (15 PS)

BF20D: 14.7 kW (20 PS)

Power recommendation is indicated on most of the boats.

40

WARNING

Do not exceed the boat manufacturer's power recommendation. Damage and injury may result.

Transom Height

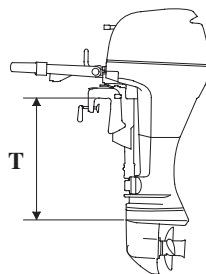

Type:	T
S:	433 mm (17.0 in)
L:	563 mm (22.2 in)
X:	703 mm (27.7 in)

Select the outboard motor which is correct for the boat transom height of your boat.

Location

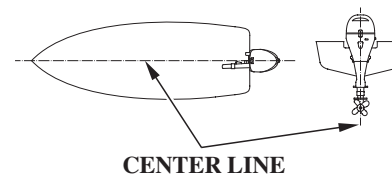

Install the outboard motor at the stern, at the center line of the boat.

The antiventilation plate of the outboard motor should be 0 – 50 mm (0 – 2 in) below the bottom of the boat.

The correct dimensions differ according to the type of the boats and the configuration of the bottom of the boats. Follow the manufacturer's recommended installation height.





INSTALLATION

Installation Height

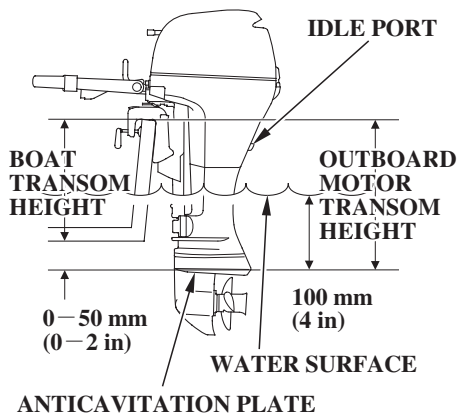

If the outboard motor is installed too low, the boat will squat and be hard to plane, and the engine will spray water that may enter the boat. It will tend to porpoise, and high-speed stability will be reduced.

If the outboard motor is installed too high, that will cause propeller ventilation.

NOTICE

The water level must be at least **100 mm (4 in)** above the anticavitation plate with the engine not running, otherwise the water pump may not receive sufficient cooling water, and the engine will overheat.

Outboard Motor Attachment

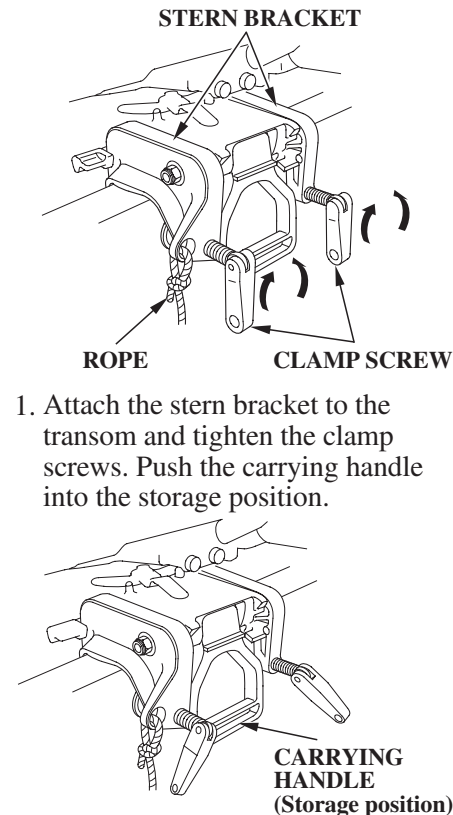



INSTALLATION

▲ CAUTION

- While operating the boat, check the tightness of the clamp screws occasionally.
- Tie a rope through the hole in the stern bracket and secure the other end of the rope to the boat. This will prevent accidental loss of the outboard motor.

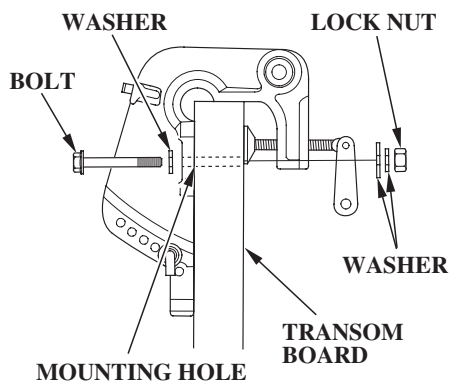

2. Apply the silicone sealant (Three Bond 1216 or equivalent) to the outboard motor mounting holes.
3. Set the outboard motor on the boat and secure with the bolts, washers, and lock nuts.

NOTE:

Standard torque:

29 – 39 N·m

(3.0 – 4.0 kgf·m , 22 – 29 lbf·ft)

The standard torque is given just as a guideline. Torque of the nut can be different according to the material of the boat. Consult with an authorized Honda outboard motor dealer.

▲ CAUTION

Install the outboard motor securely. Loosely mounted outboard motor can result in accidental loss of the outboard motor and damage and injury to the equipment and personnel.





INSTALLATION

Outboard Motor Angle (Cruising)

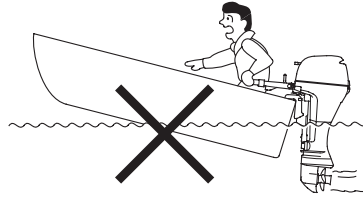

**INCORRECT
CAUSES BOAT TO "SQUAT"**

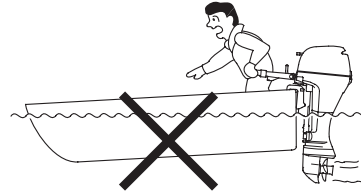

**INCORRECT
CAUSES BOAT TO "PLOW"**

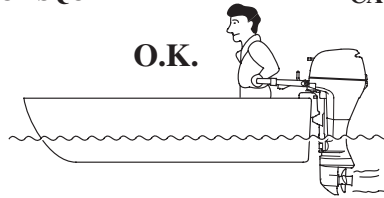

**CORRECT
GIVES MAXIMUM PERFORMANCE**

Install the outboard motor at the best transom angle for stable cruising and maximum power.

Transom angle too large: Incorrect causes boat to "squat."

Transom angle too small: Incorrect causes boat to "plow" (Sprayed water may enter the boat).

The transom angle differs according to the combination of the boat, outboard motor, and propeller, and the operating conditions.

< Outboard Motor Angle Adjustment >

Adjust the outboard motor so that it is perpendicular to the water surface (i.e. axis of the propeller is parallel with the water surface).





INSTALLATION

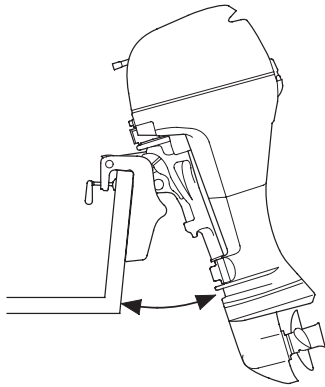

There are five adjusting stages (XH and R type).

There are four adjusting stages (G and T type).

Tilt the outboard motor to the designated tilt angle.

(manual tilt XH type/R type)

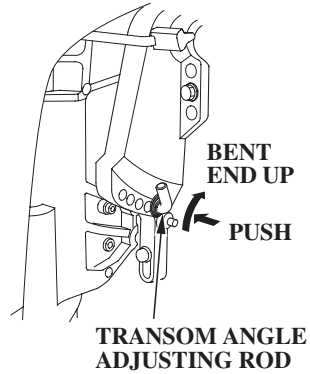

(G type/T type)

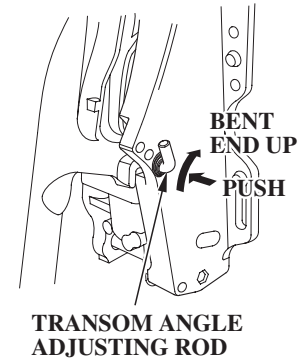

Push in the adjusting rod, twist upwards to the unlocked position and pull out to remove.

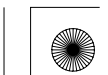



INSTALLATION

(XH type/R type/G type/T type)

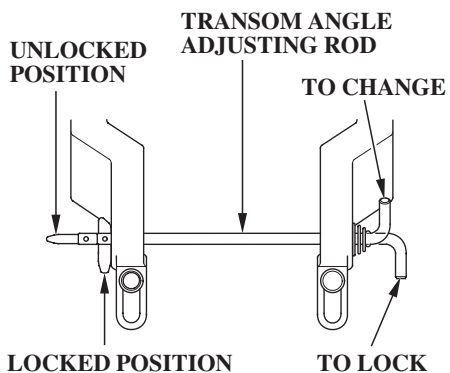

Inserting the adjusting rod in the proper hole, twist it down to lock. After locking, pull the adjusting rod and be sure it is not withdrawn.

(manual tilt SH type/LH type)

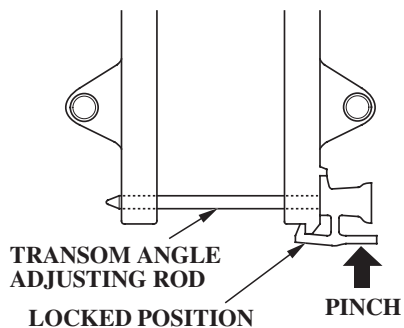

Pinch the adjusting rod end and pull out to remove.

Inserting the adjusting rod in the proper hole, and lock it. After locking, pull the adjusting rod and be sure it is not withdrawn.

NOTICE

To prevent damage to the outboard motor or boat, make sure the adjusting rod is locked.

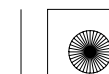



INSTALLATION

Battery Connections

Use a battery which has 12V-35 Ah or more specifications. The battery is an optional part (i.e. part to be purchased separately from the outboard motor).

▲WARNING

Batteries produce explosive gases: If ignited, an explosion can cause serious injury or blindness. Provide adequate ventilation when charging.

- **CHEMICAL HAZARD: Battery electrolyte contains sulfuric acid. Contact with eyes or skin, even through clothing, may cause severe burns. Wear a faceshield and protective clothing.**
- **Keep flames and sparks away, and do not smoke in the area. ANTIDOTE: If electrolyte gets into your eyes, flush thoroughly with warm water for at least 15 minutes and call a physician immediately.**

- **POISON: Electrolyte is poison. ANTIDOTE:**
 - **External: Flush thoroughly with water.**
 - **Internal: Drink large quantities of water or milk. Follow with milk of magnesia or vegetable oil, and call a physician immediately.**
- **KEEP OUT OF REACH OF CHILDREN.**

Place the battery in the battery box and fix the battery box securely to the hull. Install the battery box in a location such that it does not topple over while the boat is cruising or is not exposed to spray or direct of sunlight.

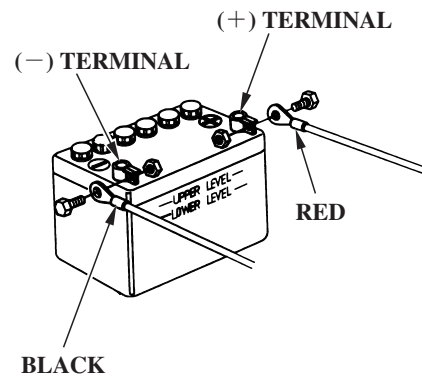

Connect the battery cables:

1. Connect the cable with the red terminal cover to the positive (+) terminal of the battery.
2. Connect the cable with the black terminal cover to the negative (-) terminal of the battery.





INSTALLATION

NOTICE

- Be sure to connect the (+) side battery cable first. When disconnecting the cables, disconnect the (-) side first then the (+) side.
- Unless the cables are properly connected to the terminals, the starter motor may fail to operate normally.
- Be careful to avoid connecting the battery in reverse polarity, as this will damage the battery-charging system in the outboard motor.
- Do not disconnect the battery cables while the engine is running. Disconnecting the cables while the engine is running, will damage the outboard motor's electrical system.
- Do not place the fuel tank near the battery.

Battery Charging DC Receptacle (Equipped type)

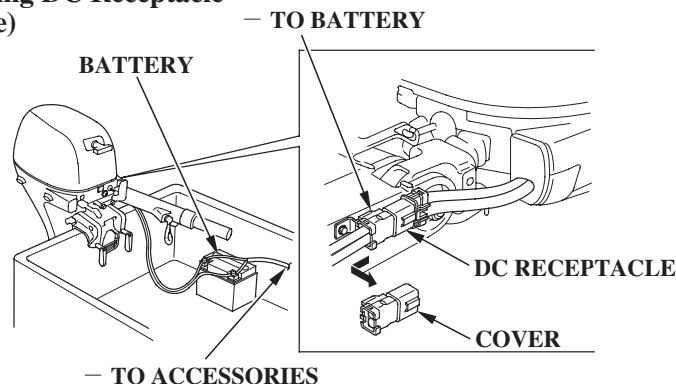

The DC receptacle provides a 12 volt, 6 amp. output for battery charging. The charging circuit is protected by a 20 amp. fuse that is accessible by removing the engine cover.

A male plug for the DC receptacle is provided with the outboard motor; connect your battery charging wires to that plug (Refer to the wiring diagram on page the inside back cover). Be sure that the positive (Red) battery cable is connected to the (+) plug terminal.

CAUTION

- Reversing the battery leads will damage the charging system and/or the battery.
- When it is not in use, keep the DC receptacle dry and clean by covering it with the rubber cap provided.

The outboard motor's 12 volt output is intended for battery charging only. Electrical accessories should be connected to the battery as shown.

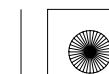



INSTALLATION (R type)

Remote Control Installation

NOTICE

Improperly installed steering system, remote control box, and remote control cable, or installing those of the different types could cause unpredictable accident. Consult an authorized Honda outboard motor dealer for proper installation.

< Location >

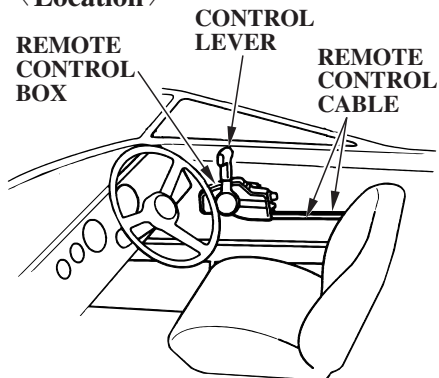

Install the remote control box in the position where is easy to operate the control lever and switches. Be sure that there are no obstacles on the route of the control cable.

< Remote Control Cable Length >

Measure the distance from the center of the remote control box via the transom corner to the center of the engine.

Recommended cable length is 300 mm (11.8 in) longer than the measured distance.

Set the cable along the pre-determined route and be sure that it is long enough to the route.

Connect the cable to the engine and be sure it is not kinked, bent sharp, pulled taut, or interfered while steering.

NOTICE

Do not bend the remote control cable as sharp as its route diameter is 400 mm (1-1/6 feet) or less, or it affects the service life of the cable and the remote control lever operation.

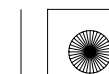



6. PRE-OPERATION CHECKS

BF8D/BF10D/BF15D/BF20D is the 4-stroke, water cooled outboard motor which uses unleaded regular gasoline for fuel. It also requires the engine oil. Check the following before operating the outboard motor.

▲ CAUTION

Perform the following pre-operation checks with the engine stopped.

Removing/Installing Engine Cover

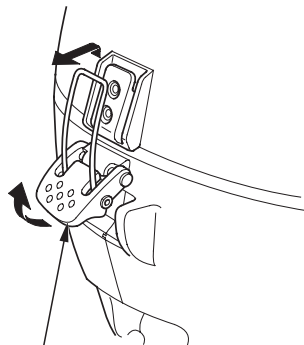

ENGINE COVER LATCH

- To remove, unlatch the engine cover latch and remove the engine cover.
- To install, set the engine cover, hook the front and rear latches, and push down the rear engine cover latch.

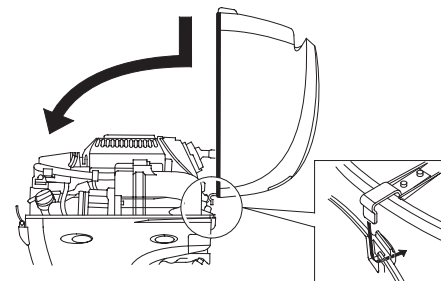

▲ WARNING

Do not operate the outboard motor without the engine cover. Exposed moving parts can cause injury.

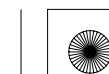



PRE-OPERATION CHECKS

Engine Oil Level

NOTICE

- **Engine oil is a major factor affecting engine performance and service life. Nondetergent and low quality oils are not recommended, because they have inadequate lubricating properties.**
- **Running the engine with insufficient oil can cause serious engine damage.**

NOTE:

To avoid incorrect gauging of the engine oil level, inspect the oil level when the engine has cooled.

< Recommended oil >

Use Honda 4-stroke oil or an equivalent high detergent, premium quality motor oil certified to meet or exceed U.S. automobile manufacturer's requirements for Service Classification SG, SH or SJ. Motor oils classified SG, SH or SJ will show this designation on the

container. Select the appropriate viscosity for the average temperature in your area. SAE 10W-30 is recommended for general, all-temperature use.

API Service Grade: Use a Fuel Efficient SG, SH or SJ oil.

NOTE:

This oil is usually identified by words such as: "Energy Conserving II". "Gas Saving", "Fuel Saving", etc.

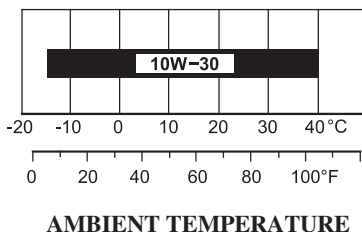

< Inspection and Refilling >

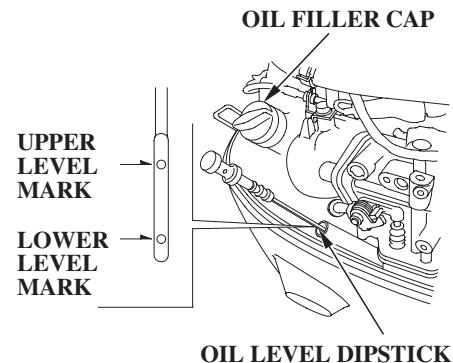

1. Position the outboard motor vertically, and remove the engine cover.
2. Remove the oil level dipstick and wipe with a clean rag.
3. Reinsert the dipstick all the way in, then pull it out and read the level. If near or below the lower level mark, remove the oil filler cap and fill to the upper level mark with the recommended oil. Tighten the oil filler cap securely.



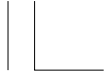

PRE-OPERATION CHECKS

When the engine oil is contaminated or discolored, replace with the fresh engine oil (see page for replacement interval and procedure).

4. Install the engine cover and lock it securely.

Oil capacity:

- 1.0 L (1.1 US qt, 0.9 Imp qt) ...when oil filter is not replaced
- 1.1 L (1.2 US qt, 1.0 Imp qt) ...when oil filter is replaced

NOTICE

Do not overfill the engine oil. Check the engine oil after refilling. Excessive engine oil as well as the insufficient oil could cause damage to the engine.

Fuel Level

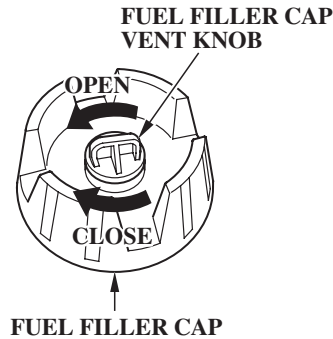

Check the fuel gauge and refill the tank if the fuel level is low.

NOTE:

Open the fuel filler cap vent knob before removing the fuel filler cap. When the fuel filler cap vent knob is firmly closed, the fuel filler cap will be difficult to remove.

After refueling, be sure to tighten the fuel filler cap firmly.

Use unleaded gasoline with a Research Octane Number of 91 or

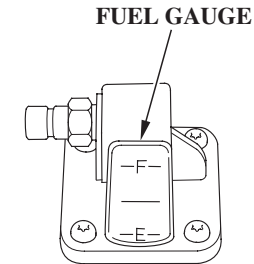

higher (a Pump Octane Number of 86 or higher). Use of leaded gasoline may cause damage to the engine.

Never use an oil/gasoline mixture or dirty gasoline. Avoid getting dirt, dust or water in the fuel tank.

Fuel tank capacity (separate tank):
12 L (3.2 US gal, 2.6 Imp gal)





PRE-OPERATION CHECKS

▲ WARNING

- **Gasoline is extremely flammable and is explosive under certain conditions.**
- **Refuel in a well-ventilated area with the engine stopped.**
- **Do not smoke or allow flames or sparks in the area where the engine is refueled or where gasoline is stored.**
- **Do not overfill the fuel tank (there should be no fuel in the filler neck). After refueling, make sure the tank cap is closed properly and securely.**
- **Be careful not to spill fuel when refueling. Spilled fuel or fuel vapor may ignite. If any fuel is spilled, make sure the area is dry before starting the engine.**
- **Avoid repeated or prolonged contact with skin or breathing of vapor.**
- **KEEP OUT OF REACH OF CHILDREN.**

Regarding use of fuel containing lead

- Fuel containing lead produces residue when burned. This residue accumulates in the cylinder head and on the exhaust valve seats and should be removed by an authorized Honda outboard motor dealer every 200 operating hours or every year, whichever comes first (refer to page 111, “Maintenance”).
- If carbon removal is not carried out as recommended, engine life and performance may be influenced.

Gasoline Containing Alcohol

If you decide to use a gasoline containing alcohol (gasohol), be sure its octane rating is at least as high as that recommended by Honda. There are two types of “gasohol”: one containing ethanol, and the other containing methanol.

Do not use gasohol that contains more than 10% ethanol.

Do not use gasoline containing more than 5% methanol (methyl or wood alcohol) and that does not also contain co-solvents and corrosion inhibitors for methanol.





PRE-OPERATION CHECKS

NOTE:

- Fuel system damage or engine performance problems resulting from the use of gasoline that contains more alcohol than recommended is not covered under the warranty.
- Before buying gasoline from an unfamiliar station, first determine if the gasoline contains alcohol, if it does, find out the type and percentage of alcohol used. If you notice any undesirable operating symptoms while using a particular gasoline. Switch to a gasoline that you know contains less than the recommended amount of alcohol.

Battery Electrolyte Level

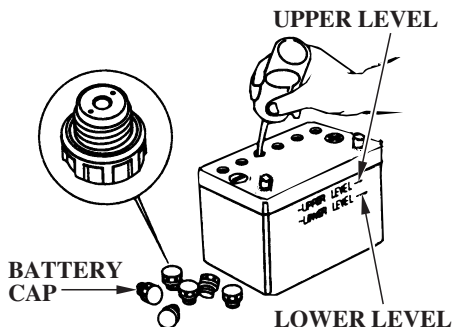

NOTICE

Battery handling differs according to the type of the battery and the instructions described below might not be applicable to the battery of your outboard. Refer to the battery manufacturer's instructions.

Check whether the battery fluid is between the upper and lower levels, and check the vent hole in the battery caps for clogging.

If the battery fluid is near or below the lower level, add the distilled water to the upper level.

▲WARNING

Batteries produce explosive gases: If ignited, an explosion can cause serious injury or blindness. Provide adequate ventilation when charging.

- **CHEMICAL HAZARD:** Battery electrolyte contains sulfuric acid. Contact with eyes or skin, even through clothing, may cause severe burns. Wear a faceshield and protective clothing.
- Keep flames and sparks away, and do not smoke in the area. **ANTIDOTE:** If electrolyte gets into your eyes, flush thoroughly with warm water for at least 15 minutes and call a physician immediately.
- **POISON:** Electrolyte is poison. **ANTIDOTE:**
 - External: Flush thoroughly with water.





PRE-OPERATION CHECKS

- Internal: Drink large quantities of water or milk. Follow with milk of magnesia or vegetable oil, and call a physician immediately.
- KEEP OUT OF REACH OF CHILDREN.

Propeller and Cotter Pin

< Inspection >

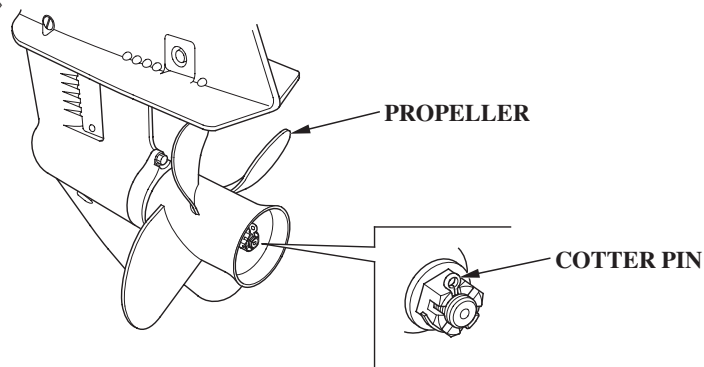

Propeller and Cotter Pin

Propeller rotates rapidly while cruising. Before starting the engine, check the propeller blades for damage and deformation and replace if necessary.

Obtain a spare propeller for the event of an unpredictable accident while cruising. If no spare propeller is available, return to the pier at low speed and replace.

Consult an authorized Honda outboard motor dealer for propeller selection.

1. Check the propeller for damage, wear, or deformation.
2. Check whether the propeller is installed properly.
3. Check the cotter pin for damage. Replace whenever the propeller is faulty.

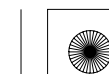



PRE-OPERATION CHECKS

Steering Handle Friction (H type)

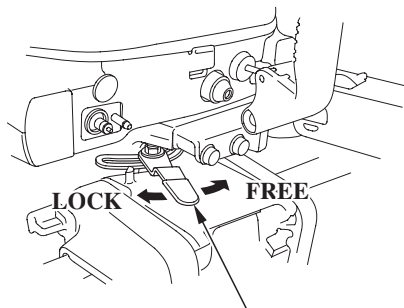

STEERING FRICTION LEVER

Check whether the handle moves smoothly.
For smooth steering, adjust the steering friction lever so that a slight drag is felt when turning.

NOTE:

Do not apply grease or oil on the friction lever. Grease or oil will reduce the friction of the lever.

Remote Control Lever Friction (R type)

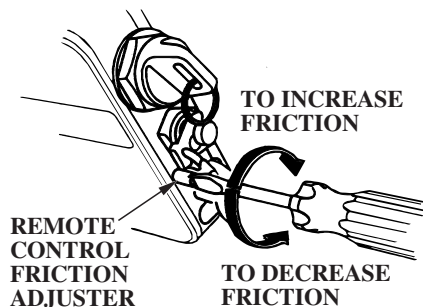

Check whether the remote control lever moves smoothly.
Friction of the lever can be adjusted by turning the remote control friction adjuster right or left.





PRE-OPERATION CHECKS

Other Checks

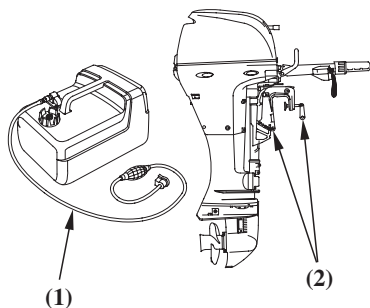

OWNER'S MANUAL

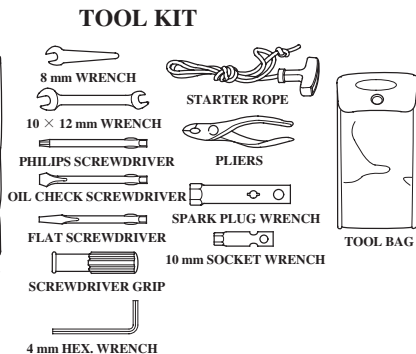

Check the following items:

- (1) The fuel hose for kinking, collapsing or a loose connection.
- (2) The stern bracket for damage and clamp screw tightened.
- (3) The tool kit for missing spare parts and tools.
- (4) The anode metal for damage, looseness or excessive corrosion. The anode metal helps to protect the outboard motor from corrosion damage; it must be exposed directly to the water whenever the outboard motor is in use. Replace the anodes

when they have been reduced to about two-thirds of their original size, or if they are crumbling.

NOTICE

The possibility of corrosion damage is increased if the anode metal is painted over or allowed to deteriorate.

- (5) The tiller handle for loose installation, wobble, or operation (H type).

- (6) The remote control lever and switch for operation (R type).

Parts/materials which should be installed on board:

- (1) Owner's Manual
- (2) Tool kit
- (3) Spare Plug(s), engine oil, Spare propeller, Cotter pin(s).
- (4) Spare emergency stop switch clip.
- (5) Other parts/materials required by laws/regulations.

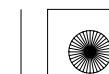



7. STARTING THE ENGINE

Fuel Tank and Vent Knob

FUEL FILLER CAP VENT KNOB

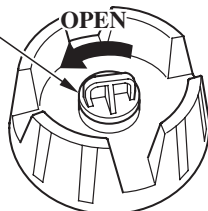

The fuel tank must be properly secured in the boat. This will protect the fuel tank from mechanical damage caused by the fuel tank shifting.

The fuel tank must be in a well-ventilated area to reduce the chance of a gasoline vapor explosion. Avoid direct sunlight on the fuel tank. Due to the fuel pump capacity, do not place the fuel tank more than 2 meters (6.6 feet) away from the outboard motor or lower than 1 meter (3.3 feet) below the outboard motor end fuel hose connector.

1. Turn the fuel filler cap vent knob counterclockwise all the way to open the vent. Allow the air pressure inside the fuel tank to equalize with the outside air. With the vent open, air can enter the fuel tank to displace the fuel as the fuel level goes down.
2. Remove the fuel filler cap and inspect the condition of the fuel filler cap and gasket. Replace the fuel filler cap or gasket if they are cracked, damaged or leak fuel.

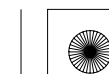



STARTING THE ENGINE

Fuel Line Connection

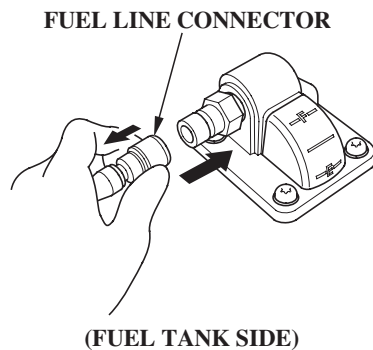

Inspect the fuel line, and the O-ring seals in the fuel line connectors. Replace the fuel line, or fuel line connectors if they are cracked, damaged or leak fuel. Be sure the fuel line is not kinked.

1. Connect the fuel line connector to the fuel tank. Be sure the fuel line connector is securely snapped in place.

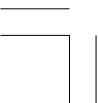



STARTING THE ENGINE

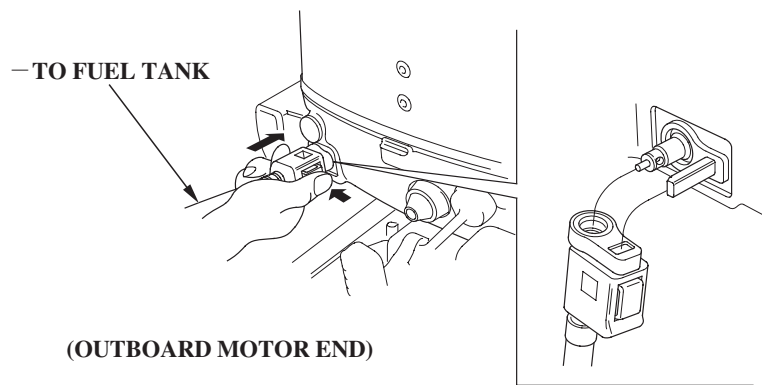

2. Connect the fuel line connector to the outboard motor. Install the outboard motor end fuel line connector with the clip toward the shift lever side. Be sure the fuel line connector is securely snapped in place. Always disconnect the fuel line when storing or transporting the outboard motor.

NOTICE

If the outboard end fuel line connector is forcibly installed in the reversed direction, the fuel line connector O-ring seal can be damaged. A damaged O-ring seal can cause a fuel leak.

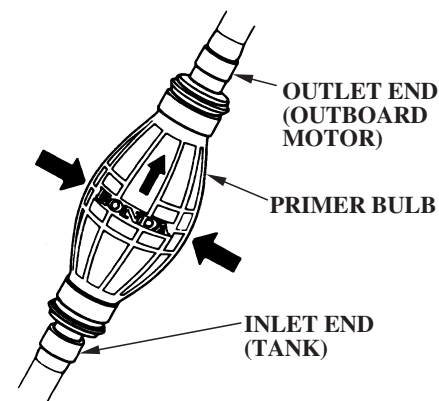

3. Hold the primer bulb so that the outlet end is higher than the inlet end. The arrow on the primer bulb points upward. Squeeze the primer bulb several times until it feels firm, indicating that fuel has reached the carburetor. Check for fuel leaks and repair any leaks before starting the engine.

Do not touch the priming bulb with the engine running or when tilting up the outboard motor. The carburetors could overflow.

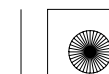



STARTING THE ENGINE (H type)

Starting the Engine

EMERGENCY STOP SWITCH CLIP

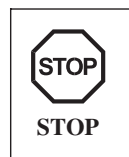

ENGINE STOP SWITCH

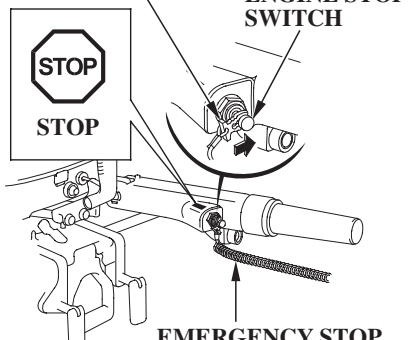

EMERGENCY STOP SWITCH LANYARD

NOTICE

The propeller must be lowered into the water, running the outboard motor out of the water will damage the water pump and overheat the engine.

1. Engage the emergency stop switch clip (located at one end of the emergency stop switch lanyard) with the engine stop switch.

Attach the other end of the emergency stop switch lanyard securely to the operator.

▲WARNING

If the emergency stop switch lanyard is not set, the boat might run out of control when the operator, for example, falls outboard and not able to operate the outboard.

For the sake of the operator's and the passengers' safety, be sure to set the emergency stop switch clip and attach one end of the emergency stop switch lanyard securely to the operator.

NOTE:

The engine does not start unless the emergency stop switch clip is set on the engine stop switch.

Store the spare emergency stop switch clip in the tool bag. Use the spare emergency stop switch clip to make the emergency engine start when the emergency stop switch lanyard is not available as, for example, the operator falls outboard.

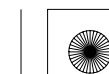



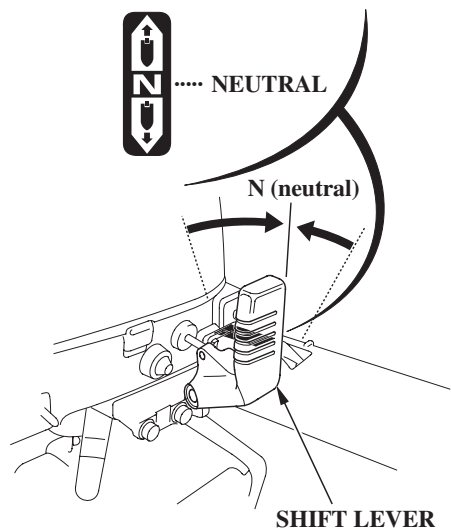

STARTING THE ENGINE (H type)

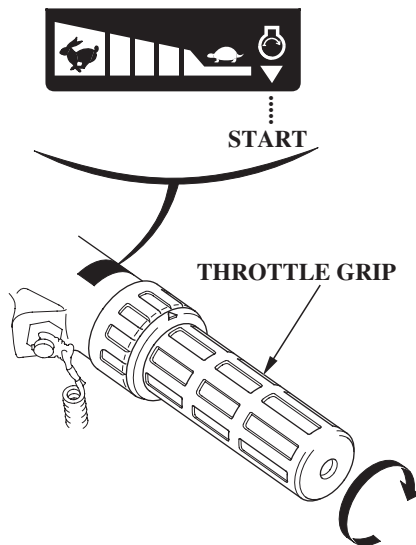

2. Move the shift lever to the N (neutral) position. The engine does not start unless the shift lever is set in the N (neutral) position.



3. Align the “” mark on the throttle grip with the projected end of the “” mark on the handle.

4. (Manual choke type)
When the engine is cold or ambient temperature is low, pull the choke knob to the ON position. (It provides rich fuel mixture to the engine.)

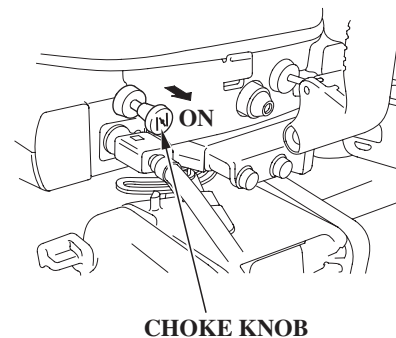

NOTE:
This engine is equipped with an accelerator pump. Do not turn the throttle grip frequently before starting. Hard starting may result. If the throttle grip has been turned frequently before starting, open the throttle grip 1/8 – 1/4 turns and start.

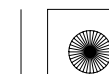



STARTING THE ENGINE (H type)

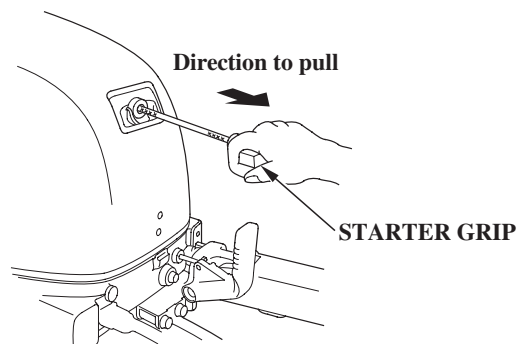

5. Recoil starter

Pull the starter grip lightly until you feel resistance, then pull briskly in the direction of the arrow as shown above.

NOTICE

- Do not allow the starter grip to snap back against the engine. Return it gently to prevent damage to the starter.
- Do not pull the starter grip while the engine is running, as that may damage the starter.

NOTE:

The “Neutral Starting System” prevents the starter rope from being pulled out for starting the engine unless the shift lever is set in the N (neutral) position.

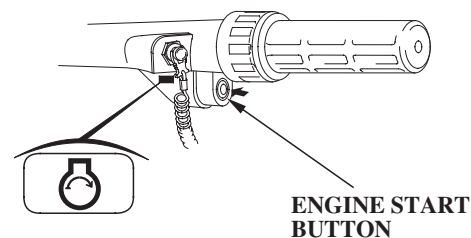

6. Electric starter (Electric starter type)

Press the engine start button and hold it there until the engine starts.

When the engine starts, release the button.

NOTICE

- The starter motor consumes a large amount of current. Do not therefore run it continuously for more than 5 seconds at a time. If the engine does not start within 5 seconds, wait at least 10 seconds before running the starter motor again.
- Do not press the engine start button while the engine is running. This may damage the starting unit.

NOTE:

The “Neutral Starting System” prevents the engine from being started unless the shift lever is set in the N (neutral) position even though the engine is cranked by the starting motor.

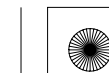



STARTING THE ENGINE (H type)

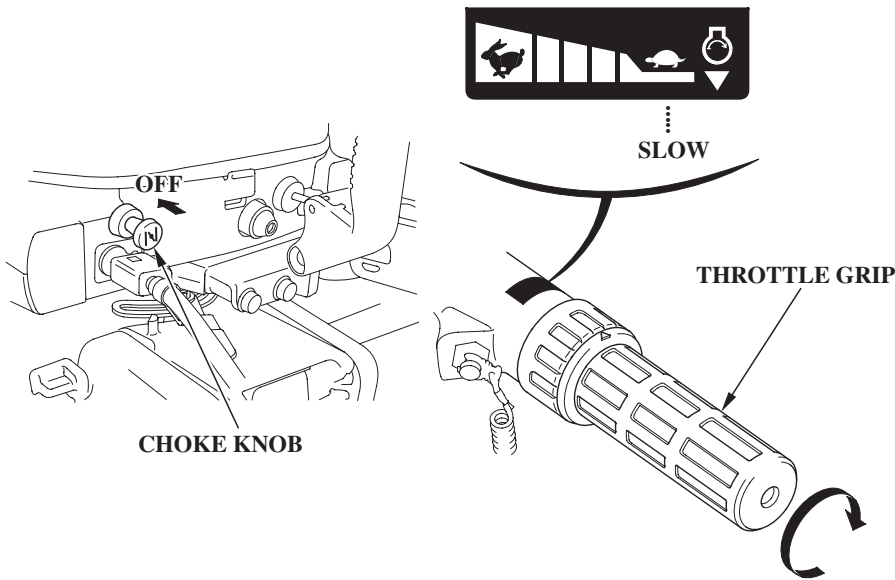

NOTE:

This engine is equipped with an accelerator pump. Do not turn the throttle grip frequently before starting. Hard starting may result. If the throttle grip has been turned frequently before starting, open the throttle grip 1/8 – 1/4 turns and start.

7. If you pulled out the choke knob to the ON position to start the engine, return it slowly to the OFF position (manual choke type), and turn the throttle grip in the SLOW direction to a position where the engine does not stall.





STARTING THE ENGINE (H type)

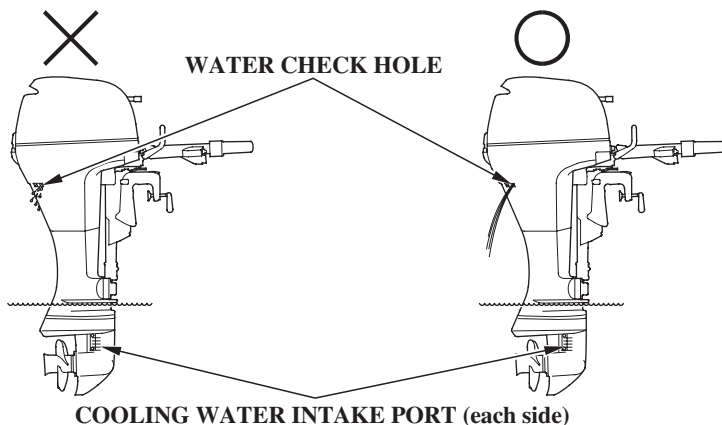

8. After starting, check whether the cooling water is flowing out of the cooling water check hole. Amount of water flowing out of the check hole might vary due to the thermostat operation, but this is normal.

NOTICE

If water does not flow out, or if steam comes out, stop the engine. Check to see if the screen in the cooling water intake port is obstructed and remove foreign

materials if necessary. Check the cooling water check hole for clogging. If water still does not flow out, have your outboard motor checked by an authorized Honda outboard motor dealer. Do not operate the engine until the problem has been corrected.

**NORMAL: ON
ABNORMAL: OFF**

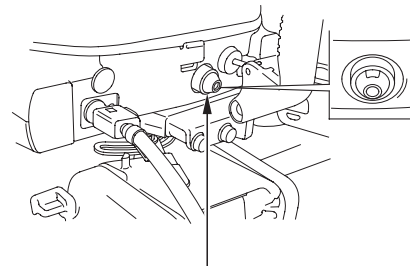

OIL PRESSURE INDICATOR LIGHT

9. Check to see if the oil pressure indicator light turns ON.

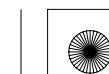



STARTING THE ENGINE (H type)

If it does not turn on, stop the engine and perform the following inspections.

- 1) Check the oil level (see page 50).
- 2) If the oil level is normal and the oil pressure indicator light does not turn ON, consult with an authorized Honda outboard motor dealer.

10. Warm up the engine as follows:
Above 5°C (41°F) — run the engine for 2 or 3 minutes.
Below 5°C (41°F) — run the engine for at least 5 minutes at 2,000 min⁻¹ (rpm) — 3,000 min⁻¹ (rpm).
Failure to completely warm up the engine will result in poor engine performance.

In an area where the temperature goes down below 0°C (32°F), the engine cooling system may freeze. High speed operation without proper engine warm up may damage the engine.

NOTE:

Before leaving the dock, check the operation of the emergency stop switch.

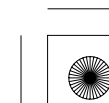
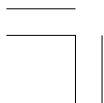



STARTING THE ENGINE (R type)

Starting the Engine

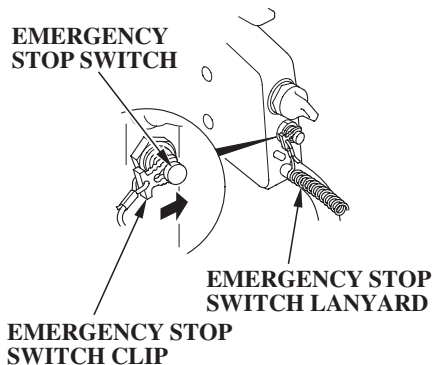

NOTICE

The propeller must be lowered into the water, running the outboard motor out of the water will damage the water pump and overheat the engine.

1. Engage the emergency stop switch clip (located at one end of the emergency stop switch lanyard) with the emergency stop switch. Attach the other end of the emergency stop switch lanyard securely to the operator.

WARNING

If the emergency stop switch lanyard is not set, the boat might run out of control when the operator, for example, falls outboard and not able to operate the outboard.

For the sake of the operator's and the passengers' safety, be sure to set the emergency stop switch clip and attach one end of the emergency stop switch lanyard securely to the operator.

NOTE:

The engine does not start unless the emergency stop switch clip is set on the emergency stop switch.

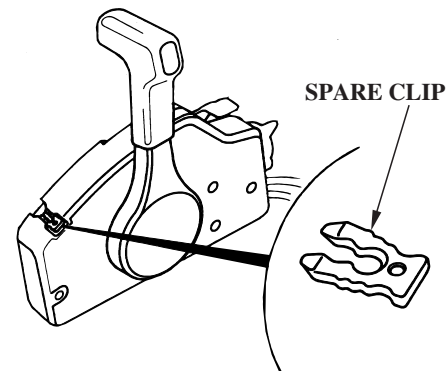

A spare clip is provided on the remote control box. Use the spare clip to make the emergency engine start when the emergency stop switch is not available as, for example, the operator falls outboard.

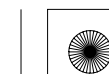



STARTING THE ENGINE (R type)

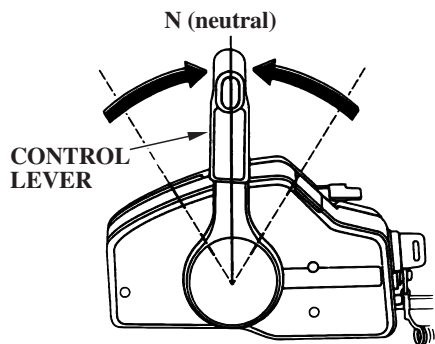

2. Set the control lever in the N (neutral) position.
The engine does not start unless the control lever is set in the N (neutral) position.

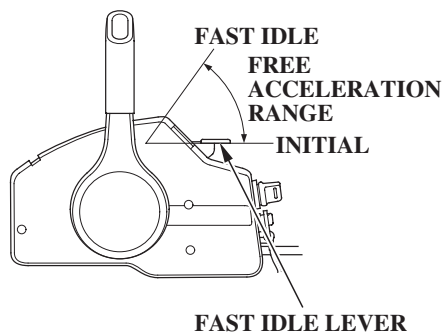

3. When the engine is cold or the ambient temperature is low, leave the fast idle lever in the initial position. (This will provide rich fuel mixture to the engine by the automatic choke.)
When the engine is warm, raise the fast idle lever to the FAST IDLE position and hold it in the position.

NOTE:

The fast idle lever does not move unless the control lever is set in the N (neutral) position.

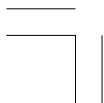



STARTING THE ENGINE (R type)

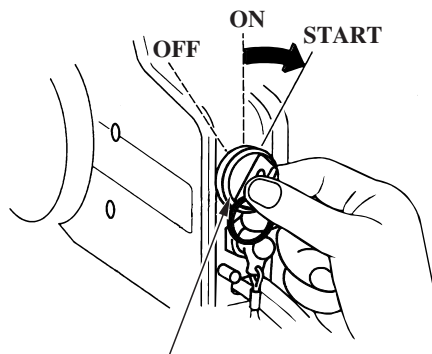

ENGINE SWITCH KEY

4. Turn the engine switch key to the START position and hold it there until the engine starts. When the engine starts, release the key, allowing it to return to the ON position.

NOTICE

- The starter motor consumes a large amount of current. Do not therefore run it continuously for more than 5 seconds at a time. If the engine does not start within 5 seconds, wait at least 10 seconds before running the starter motor again.
- Do not turn the engine switch key to the START position while the engine is running.

NOTE:

The “Neutral Starting System” prevents the engine from being started unless the control lever is set in the N (neutral) position even though the engine is cranked by the starting engine.

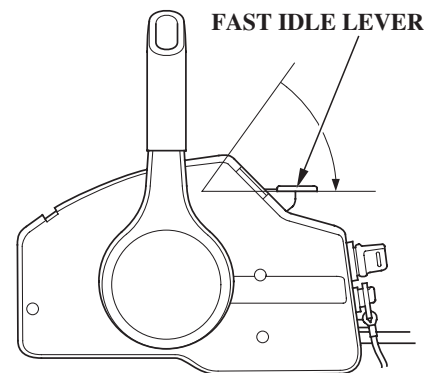

5. If the fast idle lever is raised, return the fast idle lever slowly to the position where the engine does not stall and hold the lever in the position.

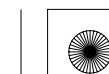



STARTING THE ENGINE (R type)

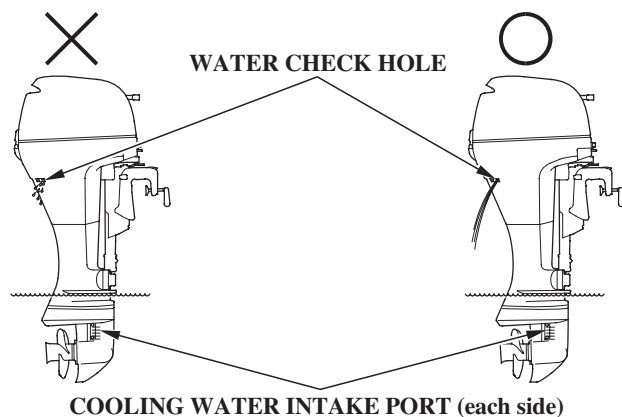

6. After starting, check whether the cooling water is flowing out of the cooling water check hole. Amount of water flowing out of the check hole might vary due to the thermostat operation, but this is normal.

NOTICE

If water does not flow out, or if steam comes out, stop the engine. Check to see if the screen in the cooling water intake port is obstructed and remove foreign materials if necessary. Check the cooling water check hole for clogging. If water still does not flow out, have your outboard motor checked by an authorized Honda outboard motor dealer. Do not operate the engine until the problem has been corrected.

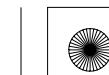



STARTING THE ENGINE (R type)

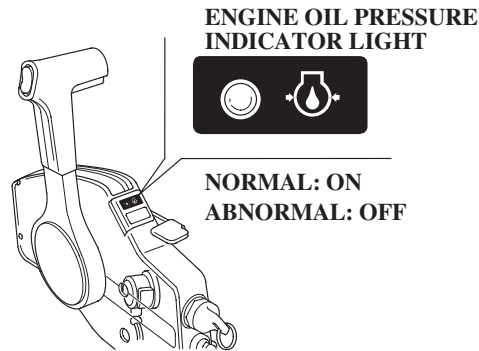

proper engine warm up may damage the engine.

NOTE:

Before leaving the dock, check the operation of the emergency stop switch.

7. Check to see if the oil pressure indicator light turns ON.

If it does not turn on, stop the engine and perform the following inspections.

- 1) Check the oil level (see page 50).
- 2) If the oil level is normal and the oil pressure indicator light does not turn ON, consult with an authorized Honda outboard motor dealer.

8. Warm up the engine as follows:
Above 5°C (41°F) — run the engine for 2 or 3 minutes.
Below 5°C (41°F) — run the engine for at least 5 minutes at 2,000 min⁻¹ (rpm) — 3,000 min⁻¹ (rpm).
Failure to completely warm up the engine will result in poor engine performance.

In an area where the temperature goes down below 0°C (32°F), the engine cooling system may freeze.
High speed operation without





STARTING THE ENGINE

Emergency Starting

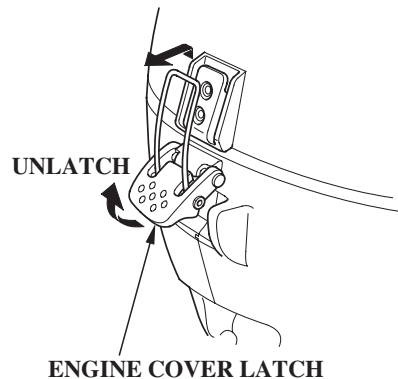

If the recoil starter does not operate properly for some reasons, the engine can be started using the spare starter rope in the tool kit.

1. Unlatch the engine cover latch and remove the engine cover.

NEUTRAL START CABLE

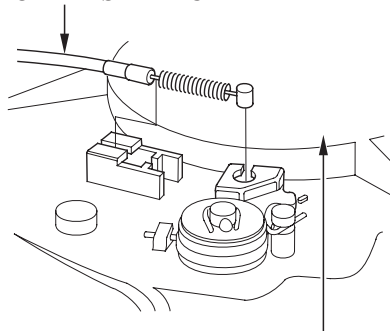

2. Move the shift lever to "F" (forward) position. Loosen the neutral start cable lock nut and disconnect the neutral start cable.

6 × 22 mm FLANGE BOLT RECOIL STARTER ASSEMBLY

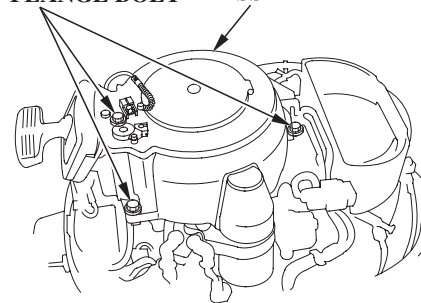

3. Remove the three 6 × 22 mm flange bolts and recoil starter assembly.

NOTE:

Take care not to lose the bolts.

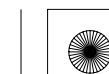



STARTING THE ENGINE

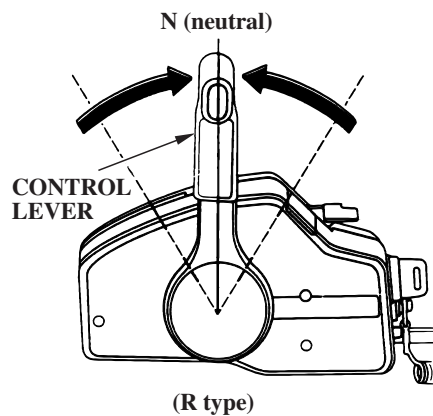
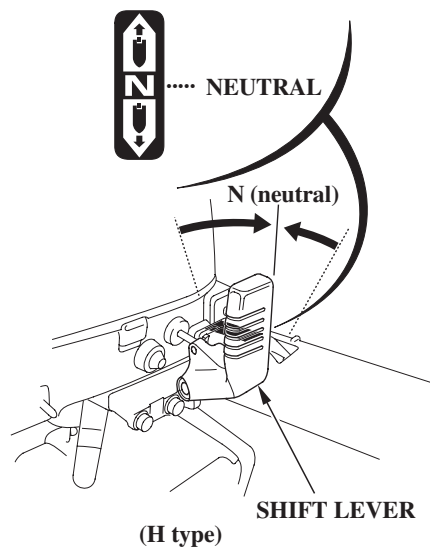

4. Set the shift lever/control lever in the N (neutral) position.

▲WARNING

The “Neutral Starting System” will not work in emergency starting. Be sure to set the shift lever/control lever into the N (neutral) position to prevent start-in-gear when starting the engine in emergency. Sudden unexpected acceleration could result in serious injury or death.

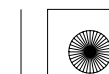



STARTING THE ENGINE

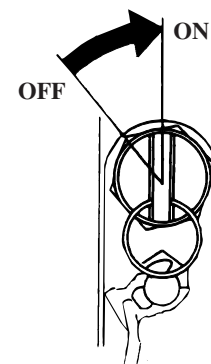
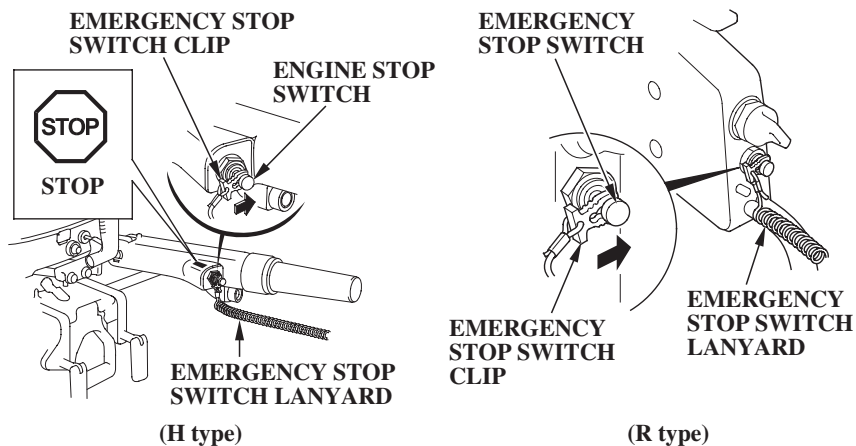

(R type)

6. If your outboard motor is the remote control type, turn the engine switch to the "ON" position.

NOTICE

The propeller must be lowered into the water, running the outboard motor out of the water will damage the water pump and overheat the engine.

5. Engage the emergency stop switch clip (located at one end of the emergency stop switch lanyard) with the engine/emergency stop switch.

Attach the other end of the emergency stop switch lanyard securely to the operator.

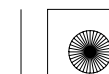



STARTING THE ENGINE

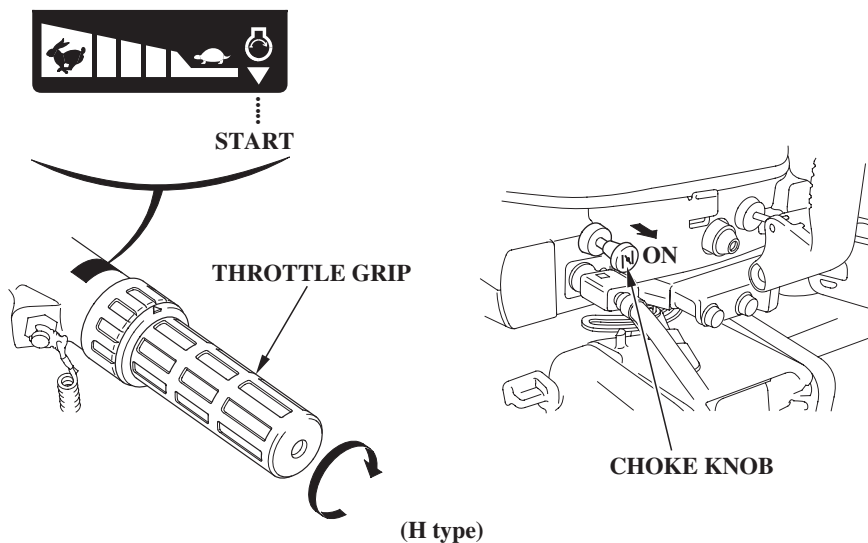

(H type)

7. Align the “⊗” mark on the throttle grip with the projected end of the “►” mark on the handle.
8. (Manual choke type)
When the engine is cold or ambient temperature is low, pull the choke knob to the ON position. (It provides rich fuel mixture to the engine.)

NOTE:

This engine is equipped with an accelerator pump. Do not turn the throttle grip frequently before starting. Hard starting may result. If the throttle grip has been turned frequently before starting, open the throttle grip 1/8 – 1/4 turns and start.

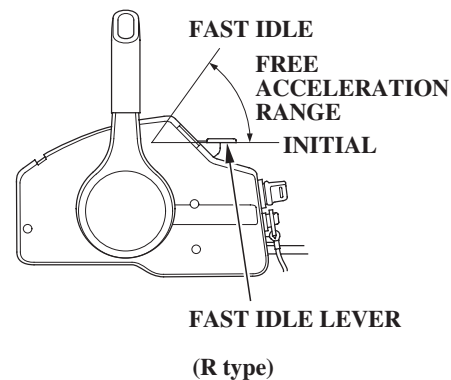

9. When the engine is cold or the ambient temperature is low, leave the fast idle lever in the initial position. (This will provide rich fuel mixture to the engine by the automatic choke.)
When the engine is warm, raise the fast idle lever to the FAST IDLE position and hold it in the position.

NOTE:

The fast idle lever does not move unless the control lever is set in the N (neutral) position.

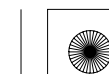



STARTING THE ENGINE

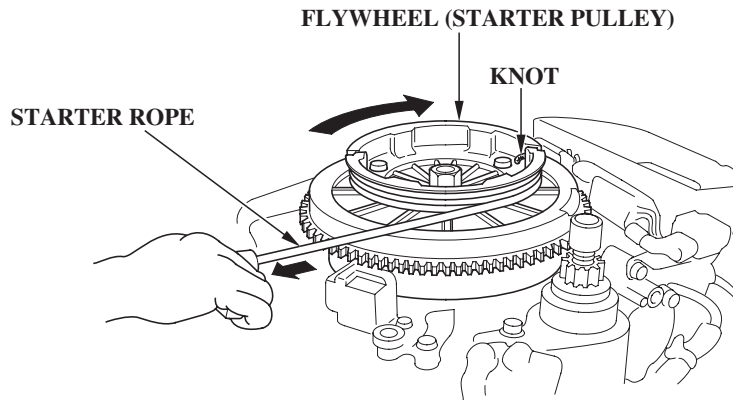

10. Set the knot at the end of the emergency starter rope in the notch in the flywheel, and while pulling the emergency starter rope clockwise around the flywheel.

11. Pull the starter rope lightly until resistance is felt, then pull briskly.

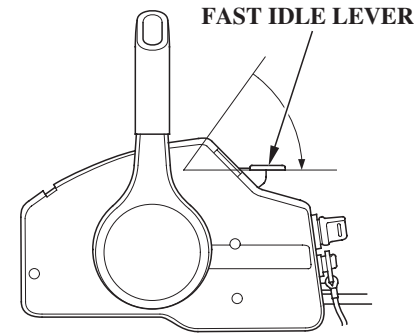

(R type)

12. If the fast idle lever is raised, return the fast idle lever slowly to the position where the engine does not stall and hold the lever in the position.





STARTING THE ENGINE

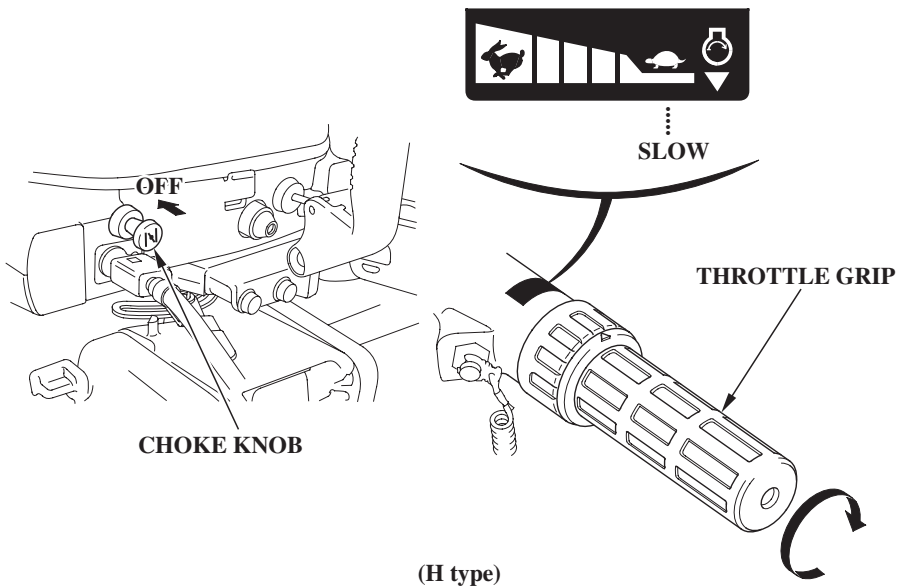

13. If you pulled out the choke knob to the ON position to start the engine, return it slowly to the OFF position (manual choke type), and turn the throttle grip in the SLOW direction to a position where the engine does not stall.

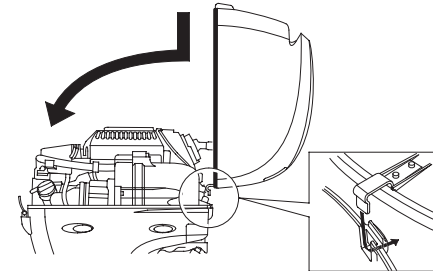

14. Reinstall the engine cover.

▲WARNING

Take extreme care when installing the engine cover. The flywheel is rotating. Do not operate without the engine cover. Exposed moving parts could cause injury and starter may damage the engine.

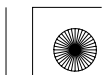



STARTING THE ENGINE

15. Attach the emergency stop switch lanyard securely to the operator and return to the closest boat landing.
16. After returning to the closest boat landing, contact your closest authorized Honda outboard motor dealer and perform the following.
 - Have the starting system and electrical system checked.
 - Have your dealer reassemble the parts removed in the emergency starting procedure.

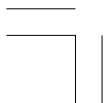



STARTING THE ENGINE

Troubleshooting Starting Problems

SYMPTOM	POSSIBLE CAUSE	REMEDY
Starter motor doesn't turn over (Electric starter type)	<ol style="list-style-type: none">1. Engine switch OFF.2. Shift lever not in NEUTRAL position.3. Blown fuse.4. Loose battery connector.	<ol style="list-style-type: none">1. Turn engine switch key START. (page 68)2. Set shift lever in NEUTRAL position. (page 61, 67)3. Replace fuse. (page 127)4. Connect battery cable securely. (page 46)
Starter motor turns but the engine doesn't start. (Electric starter type) Pull the starter rope slowly until a resistance is felt, then pull briskly.	<ol style="list-style-type: none">1. Out of fuel.2. Vent knob not open.3. Primer bulb not squeezed.4. Engine flooded.5. Weak battery. (Electric starter type)6. Plug cap is not installed properly.7. Emergency stop switch clip is not set.	<ol style="list-style-type: none">1. Supply fuel. (page 51)2. Open vent knob. (page 57)3. Squeeze primer bulb to supply fuel. (page 59)4. Clean and dry spark plug. (page 117)5. Start using emergency starter rope. (page 71)6. Install plug cap securely. (page 118)7. Set emergency stop switch clip. (page 60, 66) <p>Have your authorized Honda outboard motor dealer charge battery.</p>

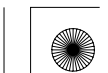



8. OPERATION (H type)

Break-in Procedure

Break-in operation allows the mating surfaces of the moving parts to wear evenly and thus ensures proper performance and longer outboard motor life.

Break-in your new outboard motor as follows.

For the initial 15 minutes:

Run the outboard motor at idling or trolling speeds (i.e. the lowest possible speed).

For the next 45 minutes:

Run the outboard motor at 2,000—3,000 min⁻¹ (rpm) (with 10%—30 % of throttle).

For the next to the second 60 minutes:

Run the outboard motor at 4,000—5,000 min⁻¹ (rpm) (with 50%—80 % of throttle).

For the initial 10 hours:

Avoid continuous full throttle (100 % throttle) operation for more than 5 minutes.

Gear Shifting

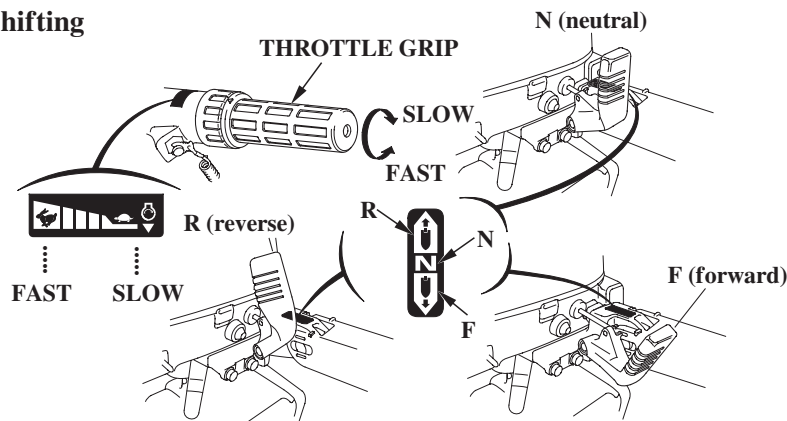

The gearshift lever has 3 positions: FORWARD, NEUTRAL, and REVERSE.

An indicator at the base of the gearshift lever aligns with the icon attached at the base of the gearshift lever.

Turn the throttle grip to SLOW to decrease engine speed before moving the gearshift lever.

NOTE:

Do not turn the throttle grip with force in the FAST direction. The throttle can be opened to FAST only in FORWARD gear.

Be sure that the tilt lever is in the RUN (LOCK) position.

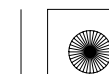



OPERATION (H type)

Steering

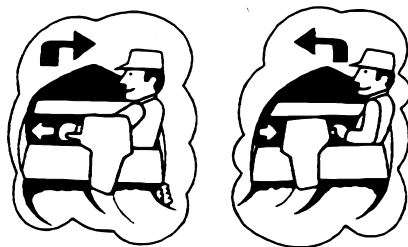

The boat swings its stern in the opposite direction in which it is to turn. To turn to the right, swing the steering handle to the left. To turn to the left, swing the steering handle to the right.

Cruising

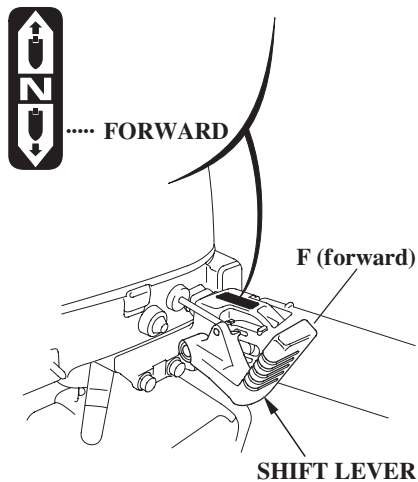

1. With the shift lever in the FORWARD position, turn the throttle grip in the FAST direction to increase the speed.
2. For the sake of fuel economy, open the throttle about 80%.

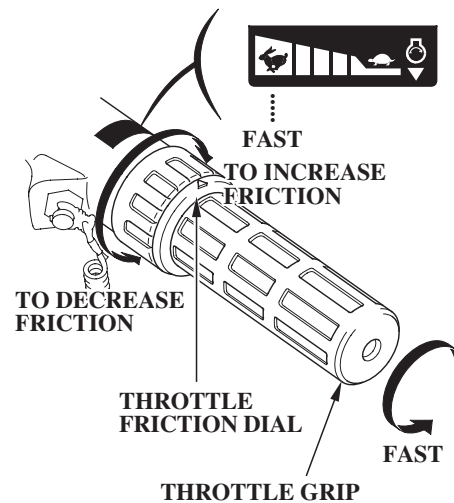

To hold the throttle at a steady setting, turn the throttle friction dial clockwise. To free the throttle grip for manual speed control, turn the friction dial counterclockwise.

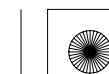



OPERATION (H type)

NOTE:

This outboard motor is equipped with an over-rev limiter in order to prevent a breakdown due to excessive engine speed.

Depending upon the running condition of the outboard motor (if the force applied to the propeller is light, for example), the limiter may operate, causing the engine speed to become unstable, thus preventing stable running.

If the engine speed becomes unstable when the outboard motor is run with the grip near the full open position, return the grip to the SLOW side until the speed becomes stable.

▲CAUTION

Do not operate without the engine cover. Exposed moving parts could cause injury; water may damage the engine.

NOTE:

For best performance, passengers and equipment should be distributed evenly to balance the boat.

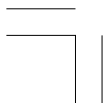



OPERATION (R type)

Gear Shifting

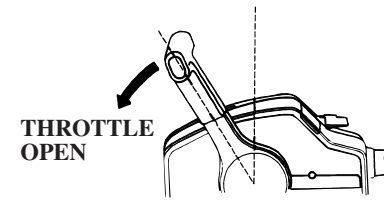
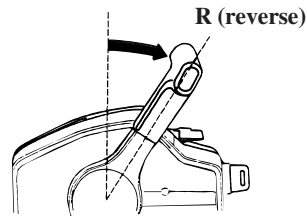
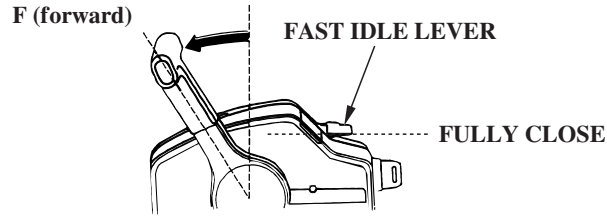
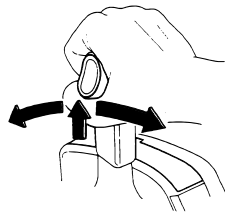
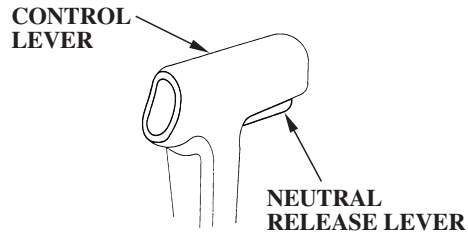

While pulling the neutral release lever, move the control lever 30° toward the FORWARD or REVERSE position to engage the clutch.
Moving the control lever further opens the throttle and the engine speed increases.

CAUTION

Avoid jerky operation of the control lever. An accident or unpredictable injury could result.

NOTE:

- The control lever might not move unless the neutral release lever is lifted fully.
- Set the fast idle lever in the fully closed throttle position, or the control lever does not operate.

Be sure that the tilt lever is in the RUN (LOCK) position.

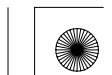



OPERATION (R type)

Cruising

POWER TILT SWITCH

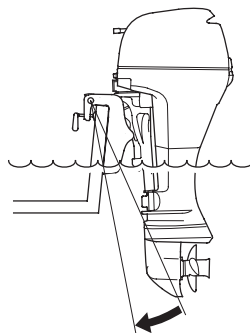
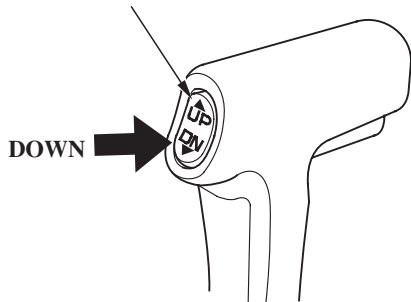

LOWERMOST POSITION

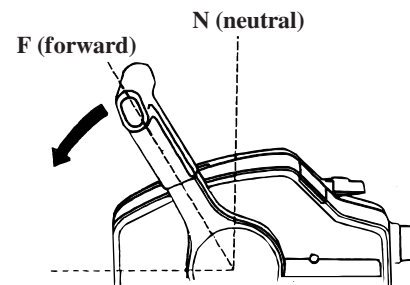

FULL OPEN

1. On the T type, press the DOWN of the power tilt switch and tilt the outboard motor at the lowermost position.

2. Move the control lever from NEUTRAL toward FORWARD position.
Moving about 30° engages the gear. Moving the control lever further opens the throttle and increases the engine speed.
3. For the sake of fuel economy, open the throttle about 80%.

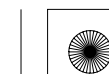



OPERATION (R type)

NOTE:

This outboard motor is equipped with an over-rev limiter in order to prevent a breakdown due to excessive engine speed.

Depending upon the running condition of the outboard motor (if the force applied to the propeller is light, for example), the limiter may operate, causing the engine speed to become unstable, thus preventing stable running.

If the engine speed becomes unstable when the outboard motor is run with the control lever near the full open position, return the control lever to the LOW side until the speed becomes stable.

▲CAUTION

Do not operate without the engine cover. Exposed moving parts could cause injury; water may damage the engine.

NOTE:

For best performance, passengers and equipment should be distributed evenly to balance the boat.

Tilting the Outboard Motor (Common)

Tilt the outboard motor to prevent the propeller and gear case from hitting the bottom when the boat is beached or stopped in shallow water.

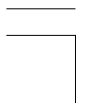



OPERATION (Manual Tilt type)

Tilting the Outboard Motor

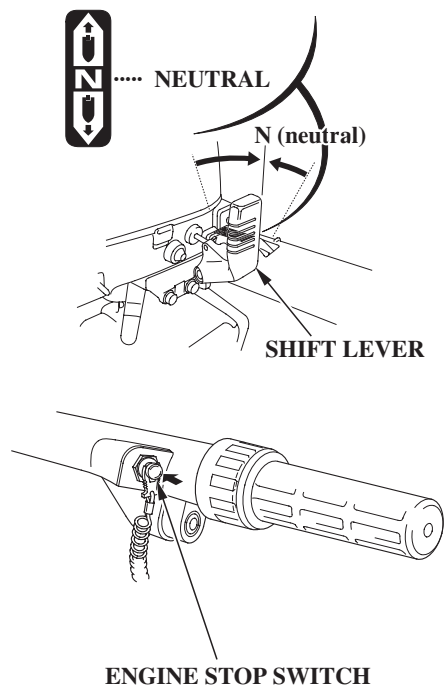

1. Move the shift lever or the control lever to the N (neutral) position and stop the engine.

ENGINE COVER GRIP

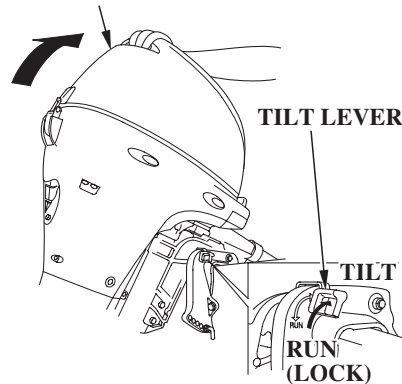

2. Move the tilt lever to the "TILT" position. Hold the engine cover grip and raise the outboard motor.

CAUTION

Do not use the throttle grip to tilt the outboard motor.

NOTE:

Before tilting up, leave the outboard motor in the running position for one minute after stopping the engine to drain the water from inside the engine.

Stop the engine and disconnect the fuel line from the outboard motor before tilting the outboard motor.





OPERATION (Manual Tilt type)

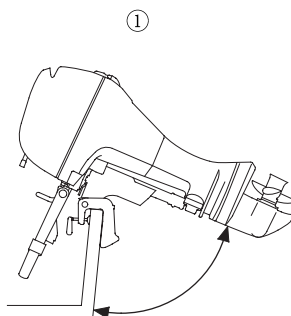
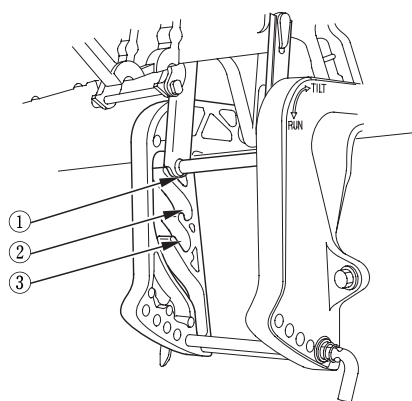

71° or 72° (when mooring)

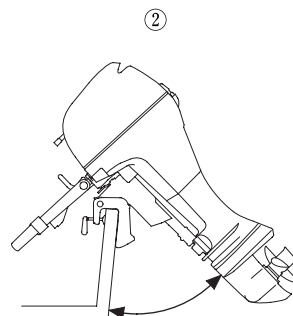

45°

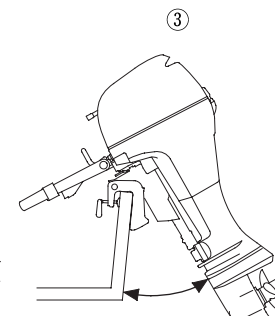

30° (when cruising in shallow water)

3. Set the tilt lever in the “TILT” position, and raise the outboard motor to either the 30°, 45° and 71° (or 72°) tilt position.

BF8D/BF10D

71° : SH/LH type

72° : XH/R type

BF15D/BF20D

71° : SH type

72° : LH/XH/R type

4. To return the outboard motor to the normal “RUN” position, move the tilt lever away from you until it stops, tilt the outboard motor slightly, then lower the outboard motor slowly.

CAUTION

- Make sure water comes out from the cooling water check hole.
- When the outboard motor is tilted up, cruise at low speed.
- Never operate in reverse when the outboard motor is tilted up. The outboard motor will rise up, causing an accident.

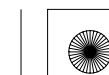



OPERATION (G type)

Tilting the Outboard Motor

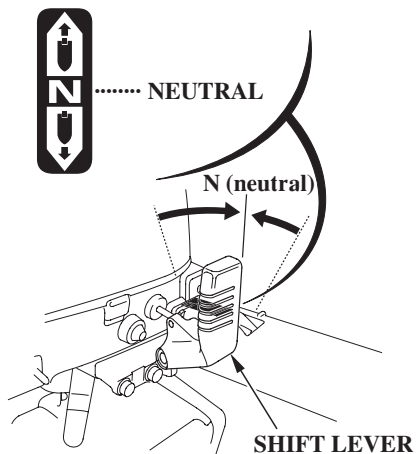

1. Move the shift lever to the N (neutral) position and stop the engine.

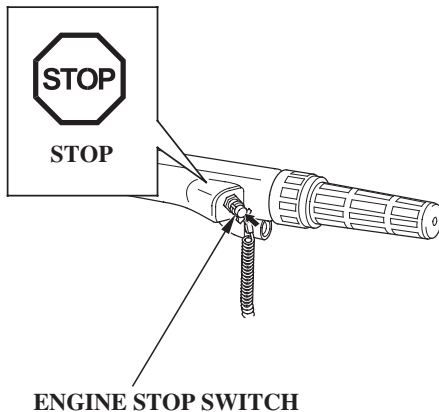

NOTE:
Before tilting up, leave the outboard motor in the running position for one minute after stopping the engine to drain the water from inside the engine.

Stop the engine and disconnect the fuel line from the outboard motor before tilting the outboard motor.

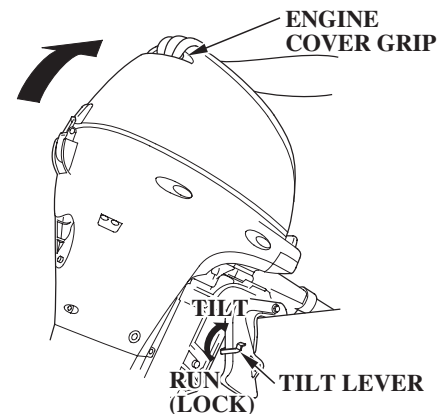

- **To tilt up the outboard motor:**
 2. Set the tilt lever in the “TILT” position. Holding the engine cover grip, raise the outboard motor to the uppermost position.
 3. Set the tilt lock lever in the “LOCK” position (see page 89).





OPERATION (G type)

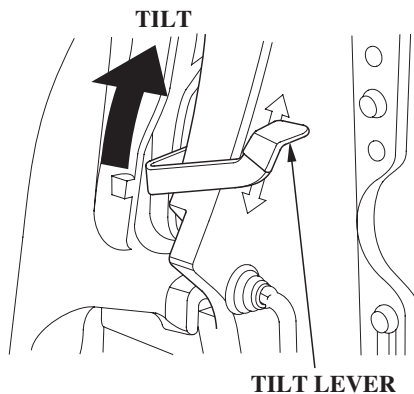
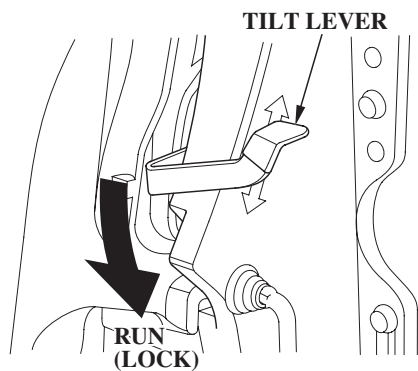

NOTICE

Be sure to use the tilt lock lever whenever the outboard motor is stored while holding it tilted up.

- To tilt down the outboard motor:
2. Check that the tilt lever is in the “TILT” position. Holding the engine cover grip, raise the outboard motor a little and set the tilt lock lever in the “FREE” position (see page 89).
 3. Holding the engine cover grip, lower the outboard motor slowly to the cruising position.

4. Check that the outboard motor is lowered to the cruising position, and set the tilt lever in the “RUN” position.

▲ CAUTION

Set the tilt lever in the TILT/RUN positions securely.





OPERATION (G type)

Moorage

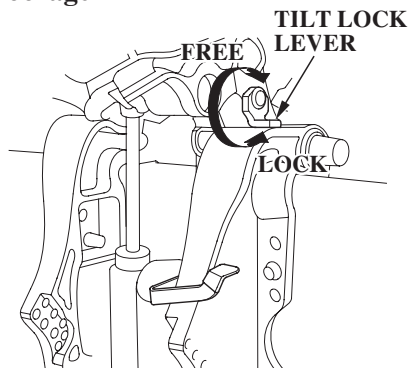

Tilt-up using the tilt lock lever.
Use this mechanism when mooring
the outboard motor.

1. Move the tilt lever to the FREE position and raise the outboard motor as far as it goes by holding it by the grip of the engine cover.
2. Move the tilt lock lever to the LOCK position and lower the outboard motor slowly.
3. Move the tilt lever to the LOCK position.

4. To tilt down, move the tilt lever to the FREE position, and move the tilt lock lever to the FREE position while lifting the outboard motor to the designated position and move the tilt lever to the LOCK position.

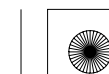



OPERATION (T type)

Tilting the Outboard Motor

The outboard motor equipped with the power tilt system can adjust the outboard motor angle only while mooring.

When operating the power tilt switch, stop the boat. Once tilt angle is fixed, it can be kept while cruising both to forward and reverse directions.

NOTE:

Before tilting up, leave the outboard motor in the running position for one minute after stopping the engine to drain the water from inside the engine.

Stop the engine and disconnect the fuel line from the outboard motor before tilting the outboard motor.

(H type)

Press UP to tilt the outboard motor up.

Press DN to tilt the outboard motor down.

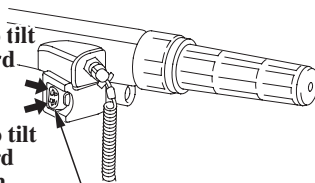

POWER TILT SWITCH

(R type)

Press UP to tilt the outboard motor up.

Press DN to tilt the outboard motor down.

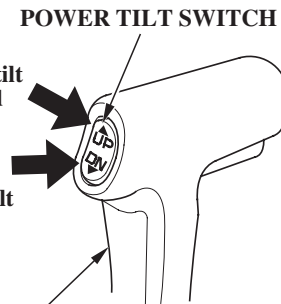

CONTROL LEVER

- To tilt up the outboard motor:
 1. Push the “UP” side of the power tilt switch and tilt up the outboard motor to the uppermost position.
 2. Set the tilt lock lever in the “LOCK” position (see page 92).
 3. Push the “DN” side of the power tilt switch and lower the outboard motor a little to make it stabilized in the tiltup position.





OPERATION (T type)

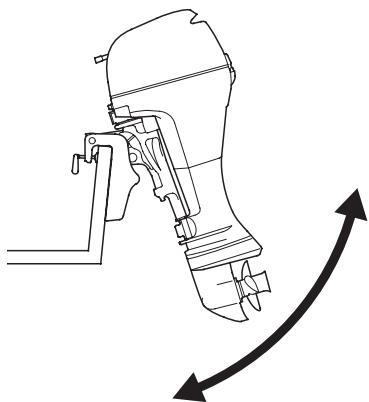

• To tilt down the outboard motor:

1. Push the “UP” side of the power tilt switch and tilt up the outboard motor to the uppermost position.
2. Set the tilt lock lever in the “FREE” position (see page 92).
3. Push the “DN” side of the power tilt switch and lower the outboard motor to the cruising position.

▲ CAUTION

- Improper transom angle results in unstable steering condition.
- Do not tilt while cruising through the rough wave, or it may cause an accident.
- Excessive transom angle can result in cavitation and racing of the propeller, and tilting up the outboard motor excessively can cause damage to the impeller pump.

Manual Relief Valve

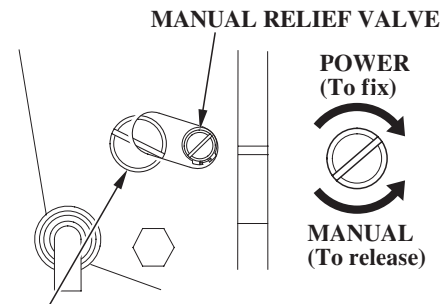

▲ WARNING

Never loosen this screw. Hydraulic oil of the power tilt system flows out.

When power tilt system does not operate because of dead battery or faulty power tilt motor, the outboard motor can be manually tilted up or down by operating the manual relief valve.

To tilt the outboard motor manually, turn the manual relief valve under the stern bracket 2 and a half turns counterclockwise using a screwdriver.





OPERATION (T type)

NOTICE

Do not loosen the manual relief valve more than three turns, or the outboard motor cannot be tilted up when the manual relief valve is retightened.

After tilting up/down manually, close the manual relief valve to lock the outboard motor in the position.

CAUTION

The manual relief valve must be tightened securely before operating the outboard motor or the outboard motor could tilt when operating in reverse.

Moorage

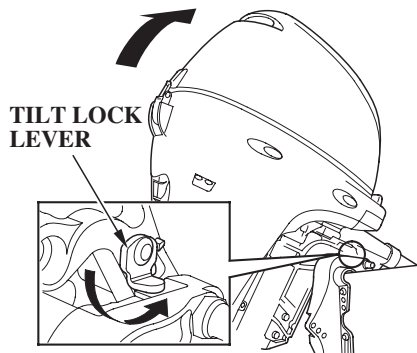

Tilt-up using the tilt lock lever.
Use this mechanism when mooring the outboard motor.

1. Raise the outboard motor as full as it goes using the power tilt switch.
2. Move the tilt lock lever to the LOCK position and lower the outboard motor until the lock lever contacts the stern bracket.

NOTE:

If more clearance is needed to swing the tilt lock lever into the LOCK position, rock the outboard motor back slightly by pulling on the engine cover grip.

3. To tilt down, raise the outboard motor slightly, move the tilt lock lever to the FREE position, and lower the outboard motor to the designated position.

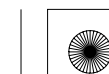



OPERATION

Mooring

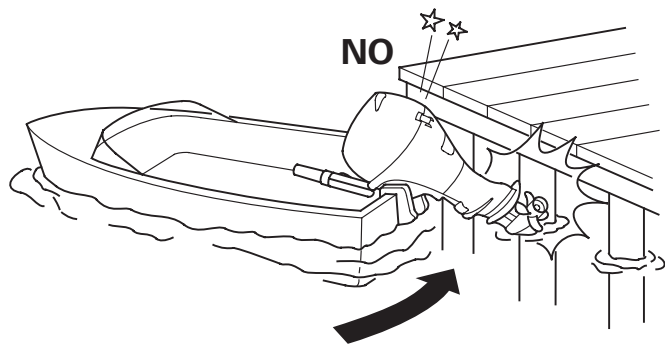

▲ CAUTION

To avoid damaging the outboard motor, use the utmost care when mooring a boat, especially when its outboard motor is tilted up. Don't allow the outboard motor to strike against the pier or other boats.

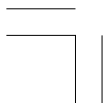



OPERATION

Engine Protection System 〈Engine Oil Pressure and Overheat Warning Systems〉

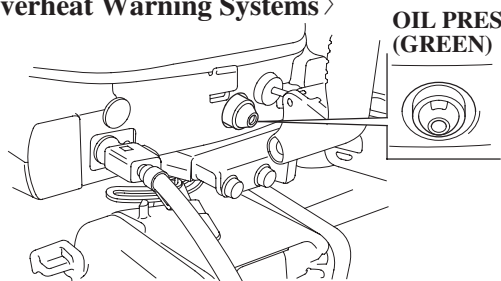

H Type

Oil Pressure Indicator

- When the green light is lit, oil pressure is OK.
- If oil pressure becomes low, the green light will go off, and the engine protection system will limit engine speed.
- Remote control types are also equipped with a buzzer that sounds when the green light goes off. The buzzer sound stops below an engine speed of 1,400 rpm.
- The engine speed does not increase if the throttle is opened widely.
- The engine speed increases gradually as soon as the cause of the warning is removed.

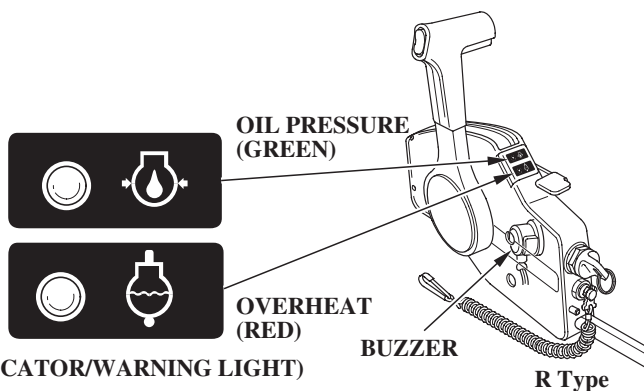

Overheat Warning Indicator

- If the engine overheats, the engine protection system will limit engine speed (All types).
- Remote control types are also equipped with a warning light and a buzzer. Red light will come on and a buzzer sounds if the engine overheats.
- The engine speed does not increase if the throttle is opened widely.
- If the overheat condition continues for 20 seconds, the engine is stopped; if the normal temperature is restored within that time, the engine speed is gradually raised to the normal cruising speed.

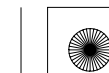



OPERATION

System Type	Low oil pressure			Overheat		
	Warning light	Buzzer sounds	Engine speed control	Warning light	Buzzer sounds	Engine speed control
H Type	○	×	○	×	×	○
R Type	○	○	○	○	○	○

System Symptom		Warning light		Buzzer	
		Oil pressure	Overheat (R type)	H type	R type
Normal		ON	OFF	○	—
Abnormal	Low oil pressure	OFF	OFF	○	Continuous beep* ¹
	Overheat	ON	ON	○	Continuous beep* ¹
	Low oil pressure & overheat	OFF	ON	○	Continuous beep* ¹

* 1: The buzzer sound stops below an engine speed of 1,400 rpm.

When the oil pressure warning system operated (green indicator light turned off):

- 1) Stop the engine immediately and check the engine oil level (see page 50).
- 2) If the oil is up to the recommended level, operate the outboard motor at low speed (within 30 seconds). The warning system is normal if it stops.
- 3) If the warning system is still operating, return to the pier at low speed and service the system.





OPERATION

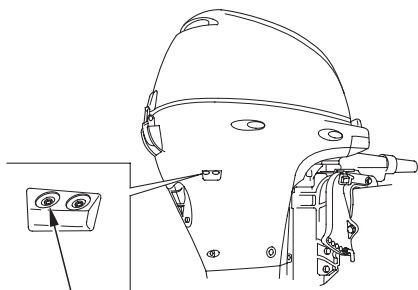

WATER CHECK HOLE

When the overheat warning system operated (red indicator light turned on):

- 1) Return the shift lever to the N (neutral) position (idle speed) immediately, and check whether water is flowing out of the cooling water check hole.

NOTICE

Running the engine without water can cause serious engine damage due to overheating. Be sure that

water flows from the cooling water check hole while the engine is running. If not, stop the engine and determine the cause of the problem.

- 2) If water is flowing, continue idling (within 30 seconds).
The warning system is normal if it stops.
- 3) If the warning system is still operating, return to the pier at low speed and service the system.

< Over-rev Limiter >

BF8D/BF10D/BF15D/BF20D outboard motor is equipped with the over-rev limiter which operates when the engine speed increases excessively for some reasons while cruising or when the propeller races while tilting up the outboard motor or changing the cruising course.

When the over-rev limiter operated:

- 1) Slow down the engine speed immediately and check the tilt angle.
- 2) If the tilt angle is proper but the engine speed is too high, stop the engine and check the outboard motor and propeller for installation condition and damage. Correct or service if necessary.





OPERATION

< Anodes >

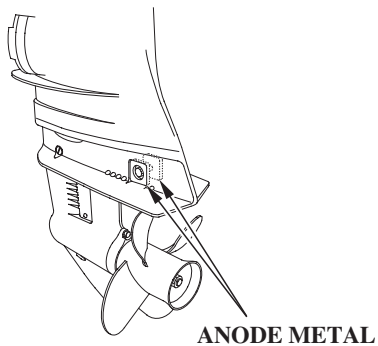

The anodes are a sacrificial material which helps to protect the outboard motor from corrosion.

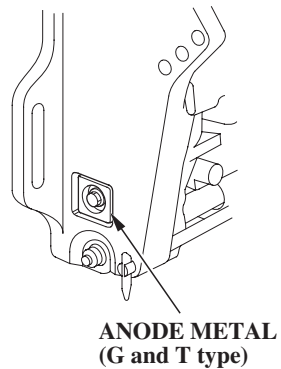

NOTICE

Painting or coating the anodes will lead to rust and corrosion damage to the outboard motor.





OPERATION

Cruising in Shallows

NOTICE

Excessive tilt angle during operation can cause the propeller to raise out of the water and cause propeller cavitation and engine over-revving. Excessive tilt angle can also damage the water pump and overheat the engine.

When operating in shallow water, tilt the outboard motor up to prevent the propeller and gear case from hitting the bottom (refer to pages 84 , 85 , 86 , 87 and 90). With the outboard motor tilted up, operate the outboard motor at low speed.

Monitor the cooling system indicator for water discharge. Be sure that the outboard motor is not tilted so high that the water intakes are out of the water.

If an excessive amount of throttle is used when operating in forward gear, the outboard motor will return to the transom angle adjusting rod. (G type)

High Altitude Operation

At high altitude, the standard carburetor fuel/air mixture will be excessively rich. Performance will decrease, and fuel consumption will increase.

High altitude performance can be improved by specific modifications to the carburetor. If you always operate the outboard motor at altitudes higher than 1,500 m (5,000 feet) above sea level, have your authorized Honda dealer perform these carburetor modifications.

Even with suitable carburetor jetting, engine horsepower will decrease approximately 3.5 % for each 300 m (1,000 foot) increase in altitude. The effect of altitude on the horsepower will be greater than this if no carburetor modification is made.

CAUTION

Operation of the outboard motor at an altitude lower than the carburetor is jetted for may result in reduced performance, overheating, and serious engine damage caused by an excessively lean air/fuel mixture.

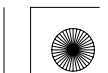



9. STOPPING THE ENGINE (H type)

Stopping the Engine

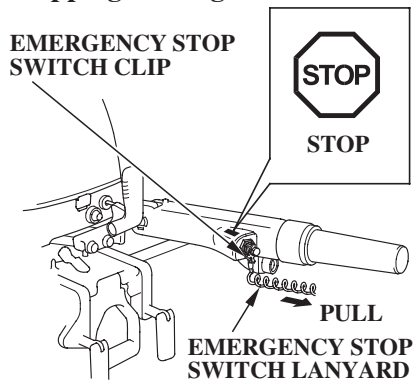

• In an emergency;

Disengage the emergency stop switch clip from the engine stop switch by pulling the emergency stop switch lanyard.

NOTE:

It is a good idea to stop the engine with the emergency stop switch lanyard from time to time to be sure that the emergency stop switch is operating properly.

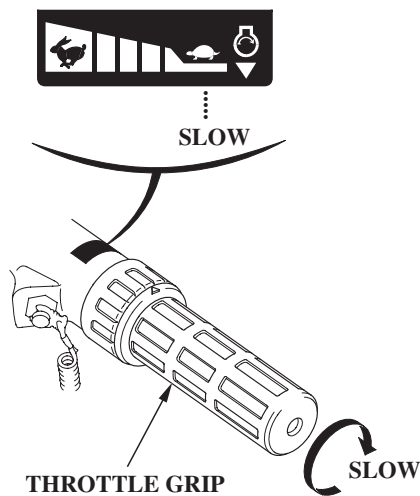

• In normal use;

1. Turn the throttle grip to SLOW position and move the shift lever to N (neutral).

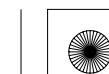
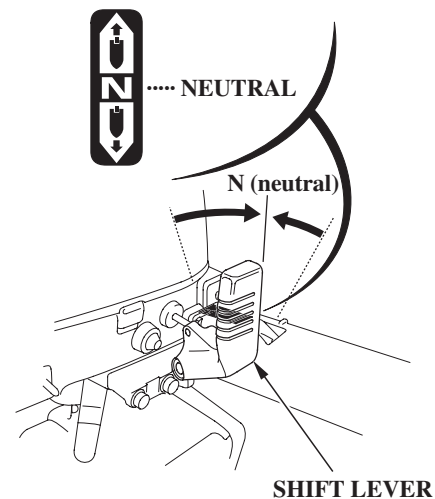



STOPPING THE ENGINE (H type)

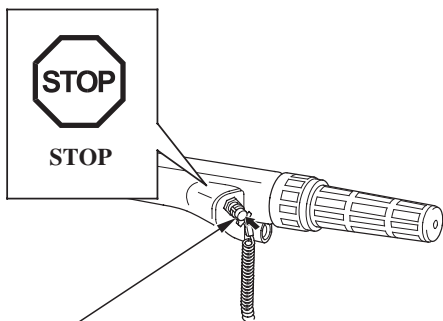

ENGINE STOP SWITCH

2. Press the engine stop switch until the engine stops.

NOTE:

After sailing with the throttle fully open, cool down the engine by running it at the idle speed for a few minutes.

NOTICE

In the event that the engine does not stop when you press the switch, and pull the emergency stop switch lanyard, pull the choke knob to stop the engine.

If the engine does not stop by pulling the choke knob, disconnect the fuel line connector (Equipped type).

3. Remove the emergency stop switch lanyard and store it.
If you are using a portable fuel tank, disconnect the fuel line if you will be storing or transporting the outboard motor.

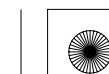



STOPPING THE ENGINE (R type)

Stopping the Engine

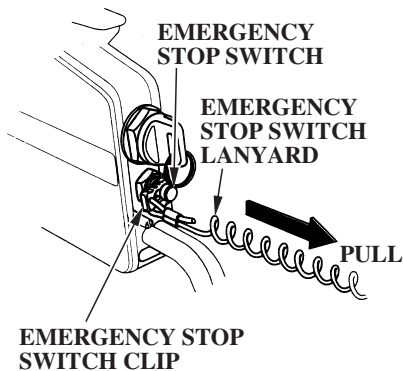

- **In an emergency;**
Disengage the emergency stop switch clip from the emergency stop switch by pulling the emergency stop switch lanyard.

NOTE:

It is a good idea to stop the engine with the emergency stop switch lanyard from time to time to be sure that the emergency stop switch is operating properly.

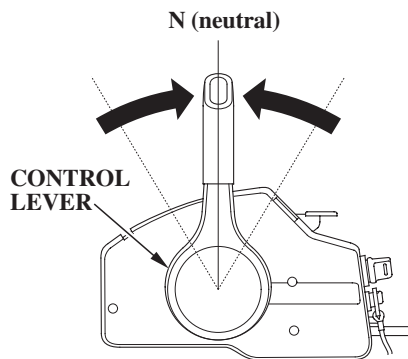

- **In normal use;**
1. Move the control lever to the N (neutral) position and turn the engine switch to the OFF (stop) position.

NOTICE

In the event that the engine does not stop when the engine switch is turned OFF, disconnect the fuel line connector and move the fast idle lever to the upmost position.

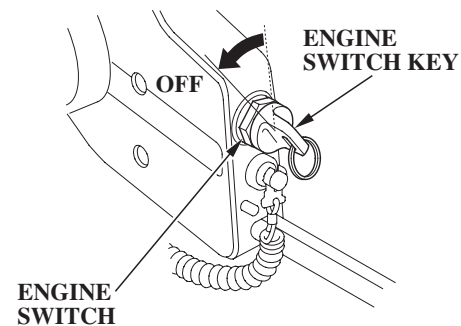

NOTE:

After sailing with the throttle fully open, cool down the engine by running it at the idle speed for a few minutes.

- 2. Remove the engine switch key and store it.

If you are using a portable fuel tank, disconnect the fuel line if you will be storing or transporting the outboard motor.





10. TRANSPORTING

Before transporting the outboard motor, disconnect and remove the fuel line in the following procedure.

▲WARNING

- **Be careful not to spill fuel. Spilled fuel or fuel vapor may ignite. If any fuel is spilled, make sure the area is dry before storing or transporting the outboard motor.**
- **Do not smoke or allow flames or sparks where fuel is drained or stored.**

Fuel Line Removal

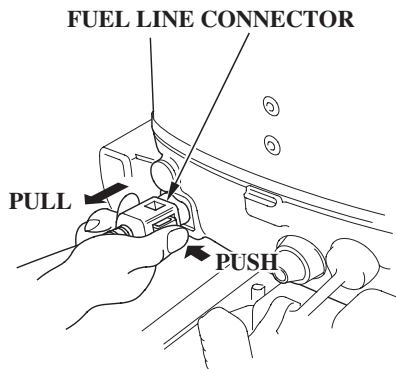

1. While pressing the fuel line connector clip, pull the fuel line connector and disconnect it from the outboard motor side joint.

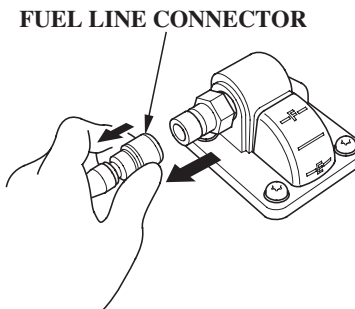

2. While pulling the fuel line connector cover, pull the fuel line connector to disconnect the fuel line connector from the fuel tank.

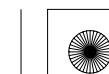



TRANSPORTING

Transporting

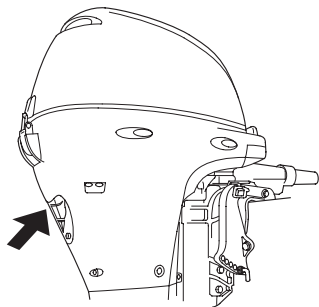

Carry the outboard motor with more than one person. To carry, hold the outboard motor by the carrying handle, or hold by the carrying handle and the lug beneath the engine cover latch as shown here. Do not carry by the engine cover.

▲ CAUTION

- Do not carry the outboard motor by the engine cover. The engine cover can be unlatched and outboard motor can drop, resulting in an accidental injury and damage.

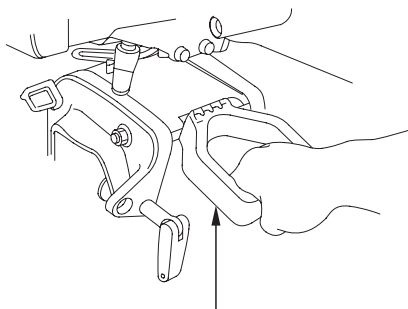

CARRYING HANDLE

- Do not carry the outboard motor by the carrying handle more than five minutes. Prolonged carrying of the outboard motor by the handle can cause the engine oil leak in the cylinders, make the engine hard starting or smoke when started.

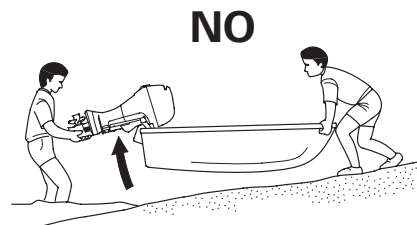

NOTICE

To avoid damaging the outboard motor, never use it as a handle for lifting or moving the boat.

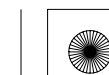



TRANSPORTING

Transport the outboard motor either vertically or horizontally as follows with the steering handle raised.

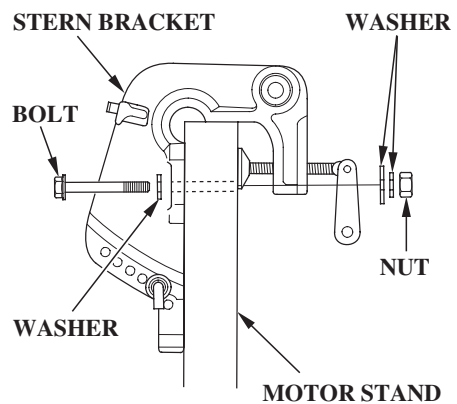

1. Attach the stern brackets to a motor stand and mount the outboard motor to the brackets.

Vertical transport

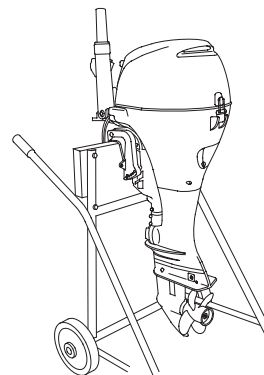

2. Transport the outboard motor with the tiller handle raised.

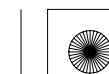



TRANSPORTING

Horizontal transport

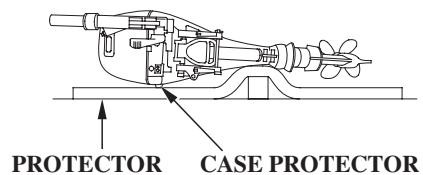

INCORRECT

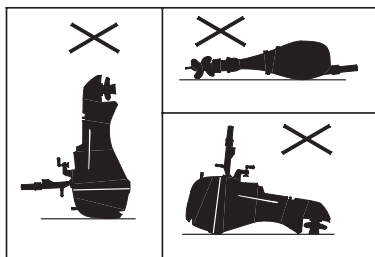

Rest the outboard motor on the case protector. (Tiller handle upside)

Always rest the outboard motor on a protector and be sure to protect it from impact and damage.

NOTICE

Any other transport or storage position may cause damage or oil leakage.

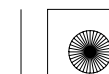



TRANSPORTING

Trailer

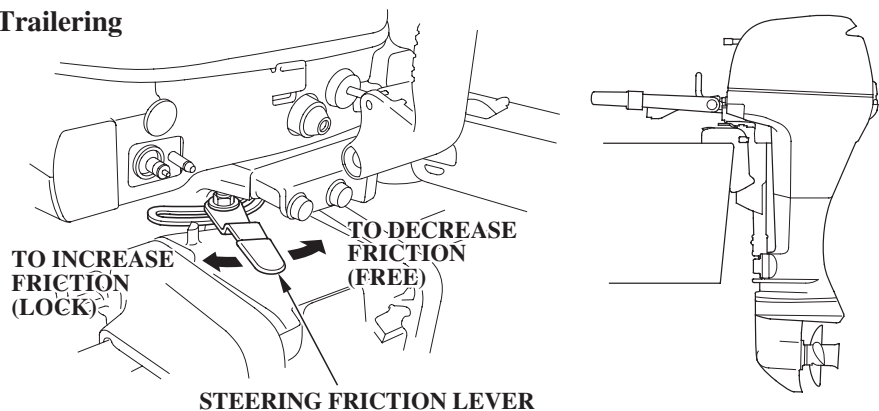

When trailering or transporting the boat with the outboard motor attached always disconnect the fuel line from the portable fuel tank and move the steering friction lever locked position.

NOTICE

Do not trailer or transport the boat with the outboard motor in the tilted position. The boat or outboard motor could be severely damaged if the outboard motor drops.

106

The outboard motor should be trailed in the normal running position. If there is insufficient road clearance in this position, then trailer the outboard motor in the tilted position using a motor support device such as a transom saver bar, or remove the outboard motor from the boat. Tilt lever should be in the tilted position.

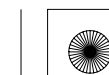



11. CLEANING AND FLUSHING

After each use in salt water or dirty water, thoroughly clean and flush the outboard motor with fresh water.

▲WARNING

- **Be sure the outboard motor is securely mounted, and do not leave it unattended while running.**
- **Keep children and pets away from the area, and stay clear of moving parts during this procedure.**

With Water Hose Joint (Optional part)

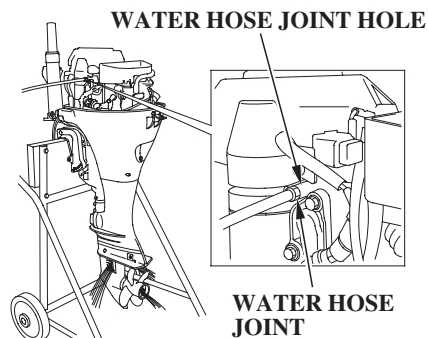

1. Disconnect the fuel line from the outboard motor.
2. Tilt down the outboard motor.
3. Wash the outside of the outboard motor with clean, fresh water.
4. Remove the engine cover.
5. Insert the water hose joint into the plug hole and connect the hose from a fresh water faucet to the hose joint.
6. Turn on the fresh water supply, and verify that there is good water pressure at the outboard motor.

NOTICE

Be sure that the water is flowing out of the drain port.

7. Flush the engine with fresh water for at least 10 minutes.
8. After flushing, remove the water hose joint, reinstall the engine cover.
9. Tilt up the outboard motor and move the tilt lever to the LOCK position.

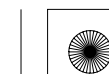



CLEANING AND FLUSHING

Without Water Hose Joint

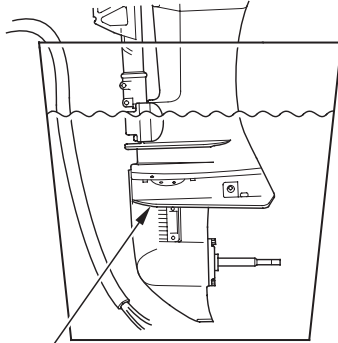

ANTICAVITATION PLATE

When the water hose joint is not used, stand the outboard in a suitable container of fresh water.

▲WARNING

For safety, the propeller must be removed.

NOTICE

Running the engine without water can cause serious engine damage due to overheating. Be sure that water flows from the cooling water check hole while the engine is

running. If not, stop the engine and determine the cause of the problem.

1. Tilt down the outboard motor.
2. Wash the outside of the outboard motor with clean, fresh water.
3. Remove the propeller (see page 127).
4. Stand the outboard motor in a suitable container of water. The water level must be at least 100 mm (4 in) above the anticavitation plate.
5. Move the shift lever or control lever to the N (neutral) position.
6. Turn on the fresh water supply to the hose.
7. Start the engine and run in neutral for at least 5 minutes to clean inside of the engine.
8. After flushing, stop the engine, and disconnect the fuel line from the outboard motor. Remove the water container, and reinstall the propeller.
9. Tilt up the outboard motor and move the tilt lever to the LOCK position.

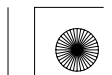



12. MAINTENANCE

Periodic maintenance and adjustment are important to keep the outboard motor in the best operating condition. Service and inspect according to the MAINTENANCE SCHEDULE.

▲WARNING

Shut off the engine before performing any maintenance. If the engine must be run, make sure the area is well ventilated. Never run the engine in an enclosed or confined area. Exhaust contains poisonous carbon monoxide gas; exposure can cause loss of consciousness and may lead to death. Be sure to reinstall the engine cover, if it was removed, before starting the engine. Lock it securely by lowering the engine cover latch.

NOTICE

- **If the engine must be run, make sure there is water at least 100 mm (4 in) above the anticavitation plate, otherwise the water pump may not receive sufficient cooling water, and the engine will overheat.**
- **Use only Honda Genuine parts or their equivalents for maintenance or repair. The use of replacement parts which are not of equivalent quality may damage the outboard motor.**

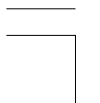



MAINTENANCE

Tool Kit and Spare Parts

The following tools and spare parts are supplied with the outboard motor for maintenance, adjustment, and emergency repairs.

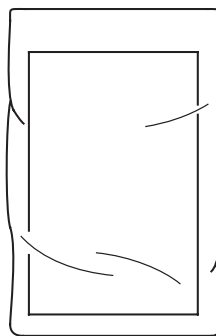

OWNER'S MANUAL



8 mm WRENCH

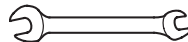

10 x 12 mm WRENCH



PHILIPS SCREWDRIVER



OIL CHECK SCREWDRIVER

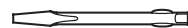

FLAT SCREWDRIVER



SCREWDRIVER GRIP



4 mm HEX. WRENCH



STARTER ROPE



PLIERS

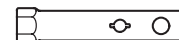

SPARK PLUG WRENCH



10 mm SOCKET WRENCH



TOOL BAG

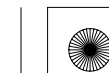



MAINTENANCE

MAINTENANCE SCHEDULE

REGULAR SERVICE PERIOD (3) Perform at every indicated month or operating hour interval, whichever comes first.			Each use	After use	First month or 20 hrs.	Every 6 months or 100 hrs.	Every year or 200 hrs.	Every 2 years or 400 hrs.
ITEM								
*	Engine oil	Check level	○					
		Change			○	○		
	Engine oil filter	Replace					○ (2)	
	Gear case oil	Change			○	○		
	Timing belt	Check					○ (2)	
	Starter rope	Check				○		
*	Carburetor linkage	Check-adjust			○ (2)	○ (2)		
*	Valve clearance	Check-adjust					○ (2)	
*	Spark plugs	Check-adjust/Replace				○		
	Propeller and cotter pin	Check	○					
	Anode (Outside engine)	Check	○					
	Anode (Inside engine)	Check						○ (2) (6)
	Idling speed	Check-adjust			○ (2)	○ (2)		
	Lubrication	Grease			○ (1)	○ (1)		
*	Fuel tank and tank filter	Clean					○	
*	Thermostat	Check					○ (2)	
*	Fuel filter	Check				○		
		Replace					○	

* Emission item for Bodensee model.

NOTE:

- (1) Lubricate more frequently when used in salt water.
- (2) These items should be serviced by your servicing dealer, unless you have the proper tools and are mechanically proficient. Refer to the Honda Shop Manual for service procedures.
- (3) For professional commercial use, log hours of operation to determine proper maintenance intervals.
- (6) Replace the anodes when they have been reduced to about two-thirds of their original size, or if they are crumbling.





MAINTENANCE

REGULAR SERVICE PERIOD (3) Perform at every indicated month or operating hour interval, whichever comes first.		Each use	After use	First month or 20 hrs.	Every 6 months or 100 hrs.	Every year or 200 hrs.	Every 2 years or 400 hrs.
ITEM							
*	Fuel line	Check	○ (8)				
		Replace		Every 2 years (If necessary) (2) (9)			
	Battery and cable connection	Check level-tightness	○				
	Bolts and Nuts	Check-tightness		○ (2)	○ (2)		
*	Crankcase breather tube	Check				○ (2)	
	Cooling water passages	Clean		○ (4)			
	Water pump	Check				○ (2)	
	Emergency stop switch	Check	○				
	Engine oil leak	Check	○				
	Each operation part	Check	○				
	Engine condition (5)	Check	○				
	Power Trim/Tilt	Check				○ (2)	
	Shift cable	Check-adjust				○ (2) (7)	

* Emission item for Bodensee model.

NOTE:

- (2) These items should be serviced by your servicing dealer, unless you have the proper tools and are mechanically proficient. Refer to the Honda Shop Manual for service procedures.
- (3) For professional commercial use, log hours of operation to determine proper maintenance intervals.
- (4) When operating in salt water, turbid or muddy water, the engine should be flushed with clean water after each use.
- (5) Upon starting, check for unusual engine sounds and cooling water flowing freely from the check hole.
- (7) The user who performs shift operation frequently will recommend you exchange of a shift cable around three years.
- (8) Check the fuel line for leaks, cracks, or damage. If it is leaking, cracked, or damaged, take it to your servicing dealer for replacement before using your outboard.
- (9) Replace the fuel line if there are signs of leaks, cracks, or damage.





MAINTENANCE

Engine Oil Change

Insufficient or contaminated engine oil adversely affects the service life of the sliding and moving parts.

Wash your hands with soap and water after handling used oil.

Oil change interval:

20 operating hours after the date of purchase or first month for initial replacement, then every 100 operating hours or 6 months.

Oil capacity:

1.0 L (1.1 US qt, 0.9 Imp qt)
...when oil filter is not replaced.

1.1 L (1.2 US qt, 1.0 Imp qt)
...when oil filter is replaced.

SAE 10W-30 engine oil or equivalent, API Service category SG, SH or SJ.

< Engine Oil Replacement >

OIL FILLER CAP

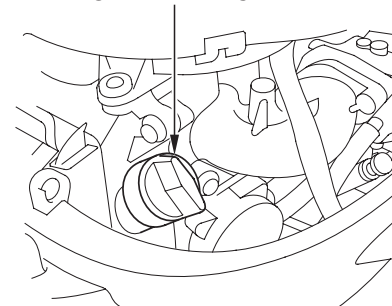

Drain the oil while the engine is still warm to assure rapid and complete draining.

1. Position the outboard motor vertically, and remove the engine cover. Remove the oil filler cap.

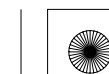



MAINTENANCE

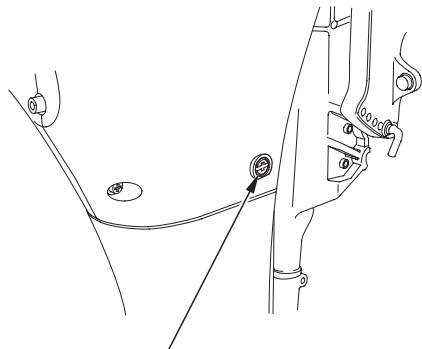

ENGINE OIL DRAIN SCREW

2. Remove the engine oil drain screw and drain the engine oil.

Reinstall the drain screw and tighten it securely.

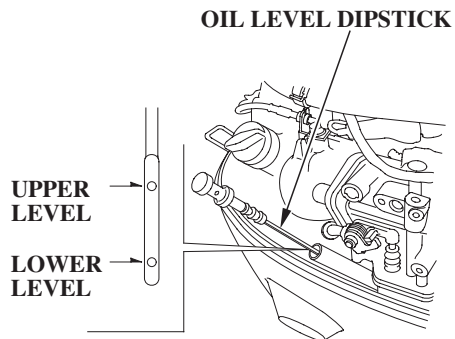

3. Refill to the upper level mark on the oil level dipstick with the recommended oil.

4. Reinstall the oil filler cap securely.

NOTE:

Please dispose of used outboard motor oil in a manner that is compatible with the environment. We suggest you take it in a sealed container to your local service station for reclamation. Do not throw it in the trash or pour it on the ground.

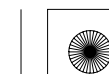



MAINTENANCE

Gear Oil Check/Change

Oil check/change interval

Oil check:

Every 6 months or 100 operating hours

Oil change interval:

20 operating hours or first month after initial use for initial change, then every 6 months or 100 operating hours.

Oil capacity:

0.29 L (0.31 US qt, 0.26 Imp qt)

Recommended Oil:

SAE #90 Hypoid gear oil or equivalent, API Service Classification (GL-4)

< Oil Level Check/Refilling >

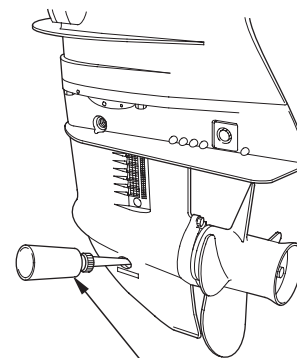
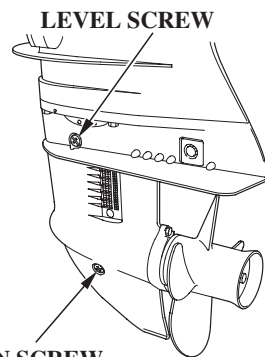

1. Position the outboard motor vertically.
2. Remove the level screw and see if oil flows out.

If no oil comes out, fill oil through the drain screw hole until the oil starts to flow out through the level screw hole.

If there is water in the oil, the water will flow out first when the drain screw is removed, or the oil will be a milky color. Consult with an authorized Honda outboard motor dealer.

NOTE:

We recommend that you use the optional gear oil bottle to fill the gear oil easily.

3. Install and tighten the drain screw and level screw securely.

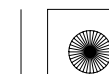



MAINTENANCE

< Oil Change >

Replacement procedure is the same as that of the refilling.

Remove the level screw and drain screw to drain the oil. Inject oil through the drain screw hole until it starts flowing out through the level screw hole. Reinstall and tighten the level screw first and then the drain screw securely.

Spark Plug Service

To ensure proper engine operation, the spark plug must be properly gapped and free of deposits.

▲ CAUTION

The spark plug becomes very hot during operation and will remain hot to awhile after stopping the engine.

Check-Adjust interval:

Every 100 operating hours or 6 months.

Replace interval:

Every 100 operating hours or 6 months.

Recommended spark plug:

CR5EH-9 (NGK)

U16FER9 (DENSO)

NOTICE

Use only the recommended spark plugs or equivalent. Spark plugs which have an improper heat range may cause engine damage.

SPARK PLUG WRENCH SPARK PLUG CAP

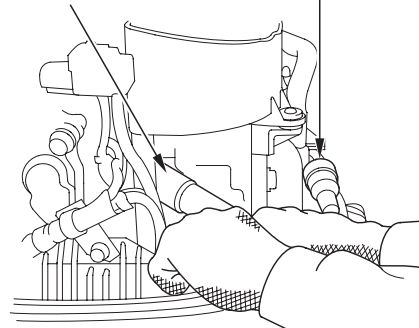

1. Remove the engine cover.
2. Remove the spark plug caps.
3. Use the wrench and screwdriver supplied in the tool kit to remove the spark plugs.

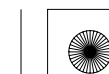



MAINTENANCE

New plug

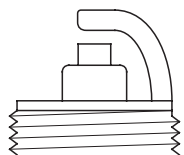

Plug needing replacement

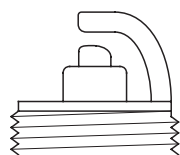

SIDE ELECTRODE

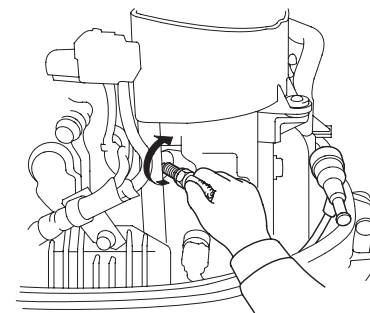
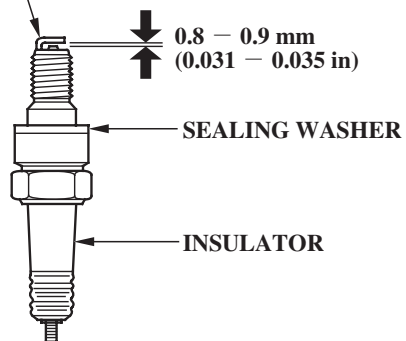

4. Inspect the spark plugs.

- (1) If the electrodes are heavily corroded or carbon-soiled, clean with a wire brush.
- (2) Replace a spark plug if the central electrode is worn. The spark plug can wear out in different ways. If the sealing washer shows signs of wear, or if the insulators are cracked or chipped, replace the spark plugs.

5. Measure the plug gaps with a feeler gauge.

The gaps should be 0.8–0.9 mm (0.031–0.035 in). Correct as necessary by carefully bending the side electrode.

6. Check that the spark plug washers are in good condition, and thread the plugs in by hand to prevent cross threading.
7. After the spark plugs are seated, tighten with a spark plug wrench to compress the washers.

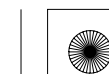



MAINTENANCE

NOTE:

If installing new spark plugs, tighten 1/2 turn after the spark plugs seat to compress the washers.

If reinstalling used spark plugs, tighten 1/8 – 1/4 turn after the spark plugs seat to compress the washers.

NOTICE

The spark plugs must be securely tightened. An improperly tightened plug can become very hot and may cause engine damage.

8. Reinstall the spark plug caps.
9. Reinstall the engine cover.

Battery Service

NOTICE

Battery handling differs according to the type of the battery and the instructions described below might not be applicable to the battery of your outboard. Refer to the battery manufacturer's instructions.

Check that the battery cables are connected securely. If the battery terminals are contaminated or corroded, remove the battery and clean the terminals.

Battery check interval:

Before each use.

▲WARNING

Batteries produce explosive gases: If ignited, an explosion can cause serious injury or blindness. Provide adequate ventilation when charging.

- **CHEMICAL HAZARD: Battery electrolyte contains sulfuric acid. Contact with eyes or skin, even through clothing, may cause severe burns. Wear a faceshield and protective clothing.**
- **Keep flames and sparks away, and do not smoke in the area. ANTIDOTE: If electrolyte gets into your eyes, flush thoroughly with warm water for at least 15 minutes and call a physician immediately.**
- **POISON: Electrolyte is poison. ANTIDOTE**
 - **External: Flush thoroughly with water.**
 - **Internal: Drink large quantities of water or milk. Follow with milk of magnesia or vegetable oil, and call a physician immediately.**
- **KEEP OUT OF REACH OF CHILDREN.**

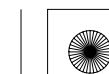



MAINTENANCE

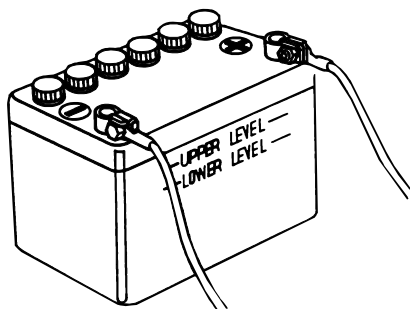

Installation check:

Check that the cables are connected to the battery terminals securely. Tighten the terminals if they are loose.

< Battery Cleaning >

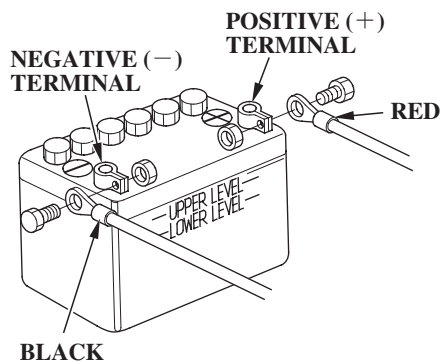

1. Disconnect the battery cable at the battery negative (-) terminal, then at the battery positive (+) terminal.
2. Remove the battery and clean the battery terminals and battery cable terminals with a wire brush or sand paper.
Clean the battery with a solution of baking soda and warm water, taking care not to get the solution or water in the battery cells. Dry the battery thoroughly.

3. Connect the battery positive (+) cable to the battery positive (+) terminal, then the battery negative (-) cable to the battery negative (-) terminal. Tighten the bolts and nuts securely. Coat the battery terminals with grease.

▲ CAUTION

When disconnecting the battery cable, be sure to disconnect at the battery negative (-) terminal first. To connect, connect at the positive (+) terminal first, then at the negative (-) terminal. Never dis/connect the battery cable in the reverse order, or it causes a short circuit when a tool contacts the terminals.

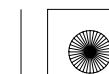



MAINTENANCE

Lubrication

Wipe the outside of the engine with a cloth dipped in oil. Apply marine anticorrosion grease to the following parts: 20 operating hours or a month after the date of purchase for initial lubrication, then every 100 operating hours or 6 months.

NOTE:

Apply anticorrosion oil to pivot surfaces where grease cannot penetrate.

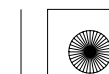
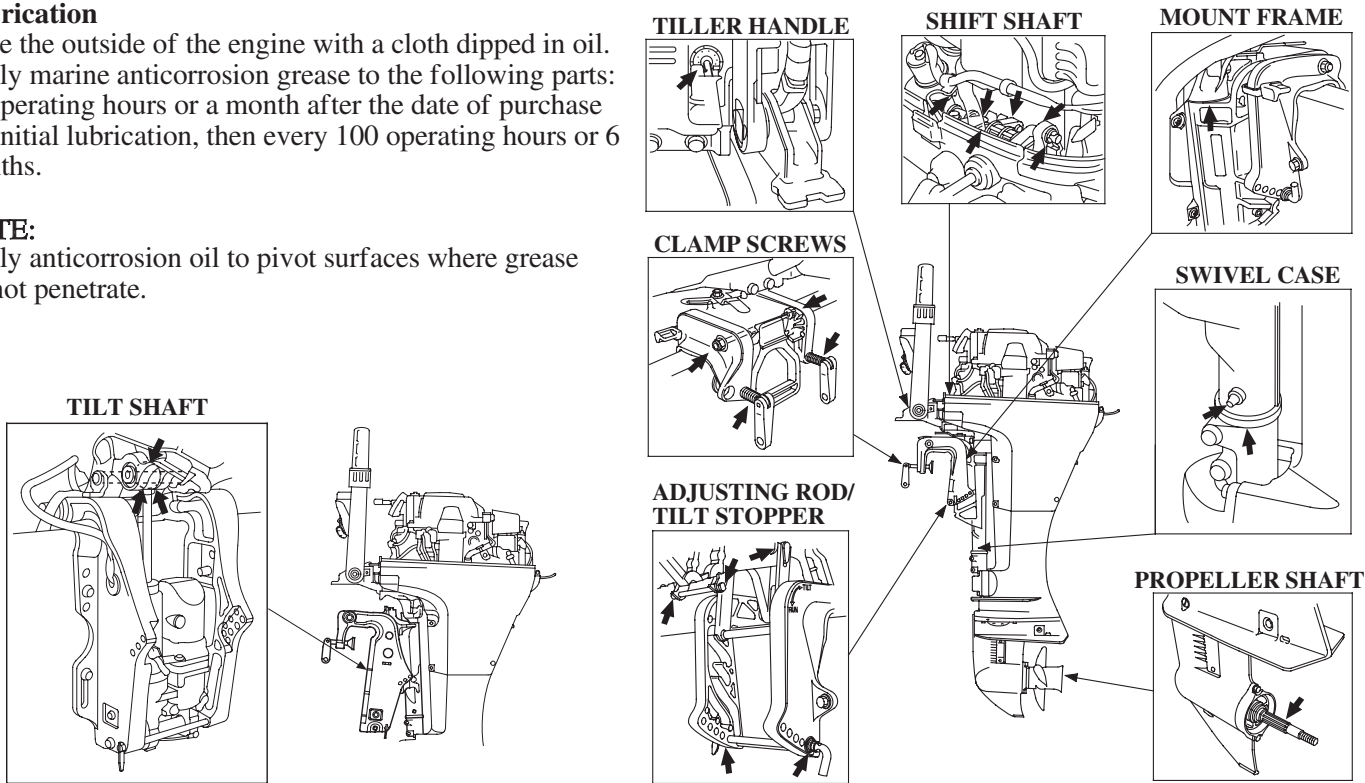



MAINTENANCE

Fuel Filter Check/Replacement

The fuel filter is located between the fuel coupling and the fuel pump. Water or sediment accumulated in the fuel filter can cause loss of power or hard starting. Check and replace the fuel strainer periodically. Inspection interval: Every 100 operating hours or 6 months.

Replacement interval:

Every 200 operating hours or every year.

▲WARNING

- **Gasoline is extremely flammable and explosive under certain conditions. Do not smoke or allow flames or sparks near the outboard motor while draining fuel.**
- **Always work in a well-ventilated area.**
- **Be sure that any fuel drained from the outboard motor is stored in a safe container.**
- **Be careful not to spill fuel when replacing the filter. Spilled fuel or fuel vapor may ignite. If any fuel is spilled, make sure the area is dry before starting the engine.**

< Inspection >

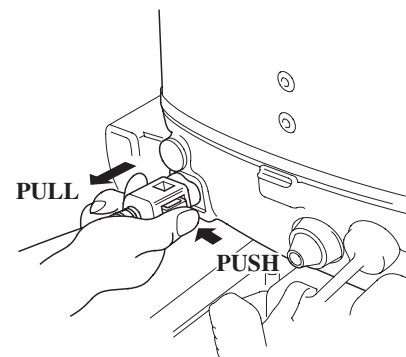

1. Disconnect the fuel line connector from the outboard motor.

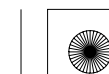



MAINTENANCE

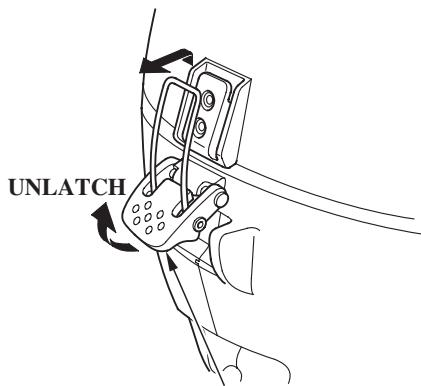

ENGINE COVER LATCH

2. Unlatch the engine cover latch and remove the engine cover.

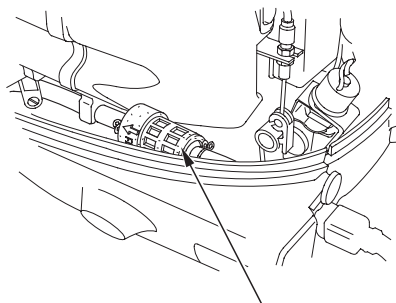

FUEL FILTER

3. Check the fuel filter for water accumulation and clogging.

< Replacement >

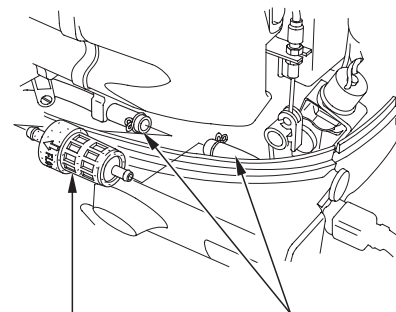

FUEL FILTER **FUEL TUBE**

1. Remove the fuel filter, disconnect the right and left fuel lines, and replace with a new fuel filter.

NOTE:

Before removing the filter, place clamps on the fuel lines on each side of the filter to prevent fuel leakage.

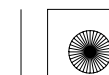



MAINTENANCE

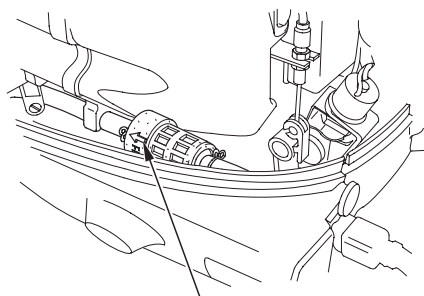

ARROW
(Fuel Flow Direction)

2. Install the new fuel filter so that the arrow mark on the fuel filter is toward the fuel pump side.

NOTE:

Fuel flow will be impeded if the filter is installed backward.

3. Connect the fuel lines to the fuel filter securely with the line clips.

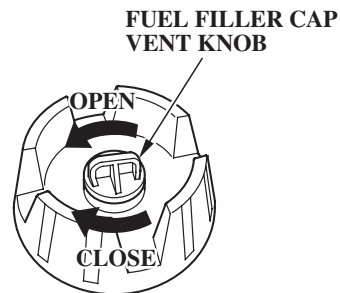

4. Turn the vent knob to OPEN side, squeeze and release the priming bulb to feed the fuel, and check for leaks.

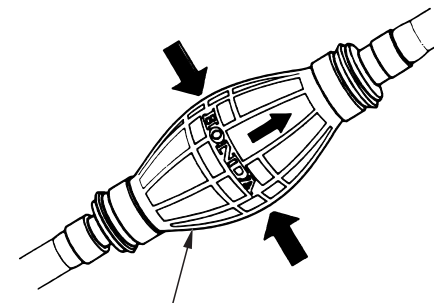

NOTE:

If loss of power or hard starting is found caused by excessive water or sediment accumulated in the fuel filter, inspect the fuel tank. Clean the fuel tank if necessary.

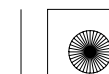



MAINTENANCE

Fuel Tank and Tank Filter Cleaning

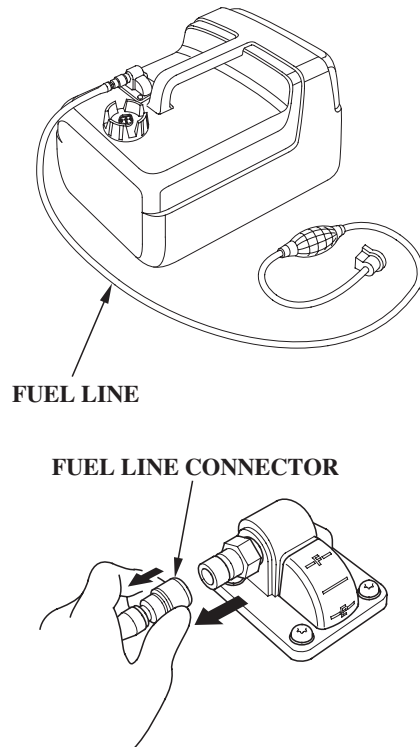

Clean the fuel tank and tank filter every year or after every 200 hours of outboard motor operation.

〈Fuel Tank Cleaning〉

1. Disconnect the fuel line from fuel tank.
2. Empty the tank, pour in a small quantity of gasoline, and clean the tank thoroughly by shaking it. Drain and dispose of the gasoline properly.

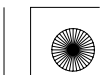



MAINTENANCE

< Tank Filter Cleaning >

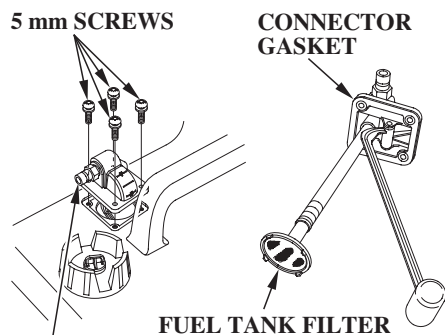

FUEL TANK FILTER JOINT (Fuel Hose Connector)

1. Remove the four 5 mm screws using a flat screwdriver, then remove the fuel hose connector and fuel tank filter from the tank.
2. Clean the filter in nonflammable solvent. Inspect the fuel tank filter and the connector gasket. Replace them if damaged.
3. Reinstall the filter and hose connector in the fuel tank. Tighten the four 5 mm screws securely.

EMISSION CONTROL SYSTEM (For Bodensee-Lake type)

The combustion process produces carbon monoxide and hydrocarbons. Control of hydrocarbons is very important because under certain conditions, they react to form photochemical smog when subjected to sunlight. Carbon monoxide does not react in the same way, but it is toxic. Honda Motor Co., Ltd. utilizes lean carburetor settings and other system to reduce carbon monoxide and hydrocarbons.

Problems that May Affect Outboard Motor Emissions

If you are aware of any of the following symptoms, have the outboard motor inspected and repaired by your authorized Honda Dealer:

1. Rough idle
2. Hard starting or stalling after starting
3. Misfiring or backfiring during acceleration

4. Poor performance (driveability) and poor fuel economy

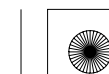



MAINTENANCE

Choke Knob Friction (Manual choke type)

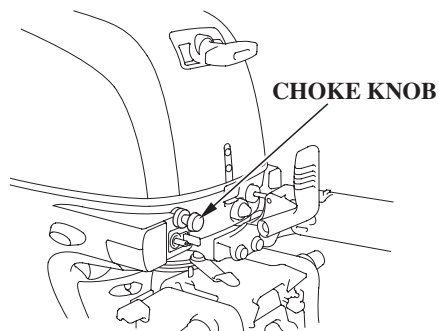

If the choke knob returns to the OFF position by itself, you can adjust the friction that holds the knob in the ON position.

FRICION ADJUSTING NUT RUBBER COVER

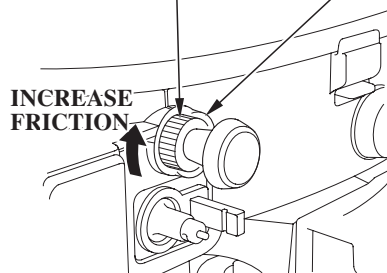

To adjust the friction, squeeze the rubber cover to grip the adjusting nut and turn it clockwise to increase the friction. Do not force the adjusting nut. If it is too hard to turn by hand, contact an authorized Honda Outboard Motor dealer for assistance.

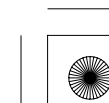
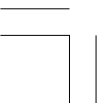



MAINTENANCE

Replacing the Fuse (Electric starter type and 6A charge coil type)

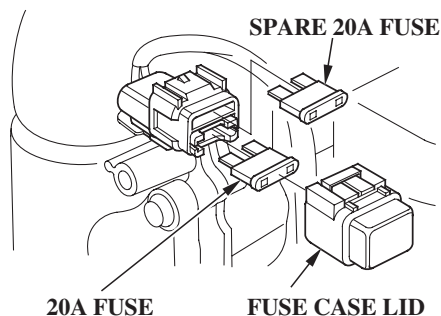

If the fuse blows, running the engine will not charge the battery. Before replacing the fuse, check the current ratings of the electrical accessories and ensure that there are no abnormalities.

〈 How to replace the fuse 〉

1. Stop the engine.
2. Remove the engine cover.
3. Remove the fuse case lid and pull the blown fuse out of the clip with your finger.
4. Push a new fuse into the clips.

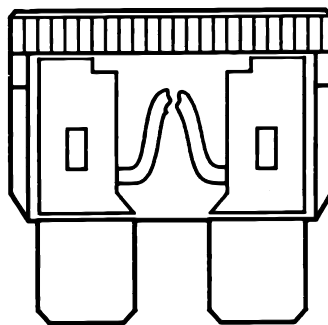

BLOWN FUSE

〈 Designated fuse 〉 20A

▲ WARNING

Never use a fuse with a different rating from that specified. Serious damage to the electrical system or a fire may result.

NOTICE

If the fuse is blown, check the cause, then replace the fuse with a spare fuse of the same rated capacity. Unless the cause is found, the fuse may blow again.

Propeller Change

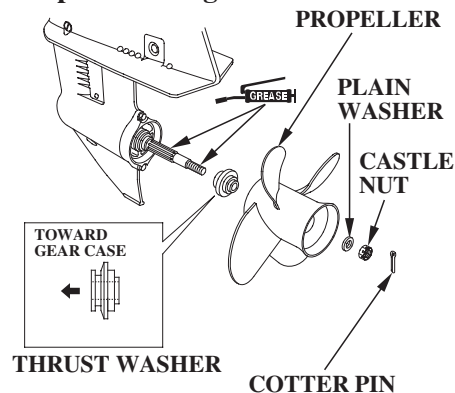

If the propeller is damaged by striking a rock, or other obstacle, replace the propeller as follows.

1. Remove the cotter pin then remove the 10 mm castle nut, 10 mm plain washer, propeller and thrust washer.

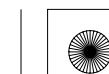



MAINTENANCE

COTTER PIN

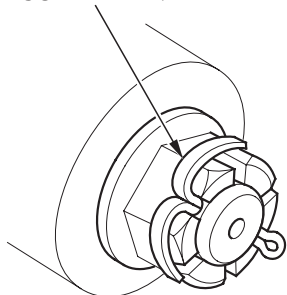

2. Install the new propeller in the reverse sequence to removal. Be sure to replace the coter pin with a new one.

CASTLE NUT

TIGHTENING TORQUE:

4.0 N·m (0.4 kgf·m, 2.9 lbf·ft)

UPPER LIMIT OF TORQUE:

17 N·m (1.7 kgf·m, 12 lbf·ft)

NOTE:

- Install the thrust washer with the grooved side toward the gear case.
- Tighten the castle nut with your hand first until the propeller has no play. Then, tighten the castle nut

128

again with a tool until the groove in the castle nut aligns with the coter pin hole. (Note that this tool is not included in the tools that come together with the outboard motor.)

- Use a genuine Honda coter pin and bend the pin ends as shown.

Servicing a Submerged Outboard Motor

A submerged outboard motor must be serviced immediately after it is recovered from the water in order to minimize corrosion.

If there is a Honda outboard motor dealership nearby, take the outboard motor immediately to the dealer. If you are far from a dealership, proceed as follows:

1. Remove the engine cover, and rinse the outboard motor with fresh water to remove salt water, sand, mud, etc.
2. Loosen the carburetor drain screw, drain the contents of the carburetor

DRAIN SCREW

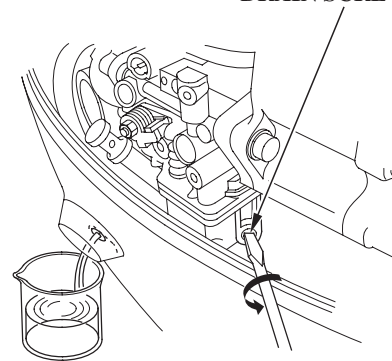

into a suitable container, then retighten the drain screw (see page 132).

3. Remove the spark plugs. Disengage the emergency stop switch clip from the engine stop switch and pull the recoil starter grip several times to completely expel water from the cylinders.

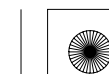



MAINTENANCE

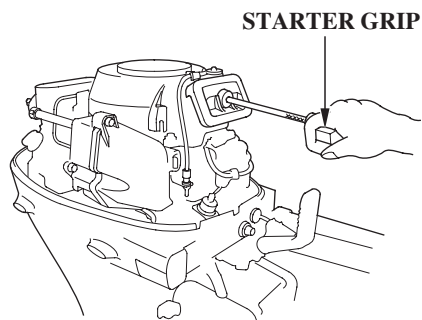

NOTICE

- When cranking the engine with an open ignition circuit (spark plugs removed from the ignition circuit), disengage the emergency stop switch clip to prevent electrical damage to the ignition system.
- If the outboard motor was running when it submerged, there may be mechanical damage, such as bent connecting rods. If the engine binds when cranked, do not attempt to run the outboard motor until it has been repaired.

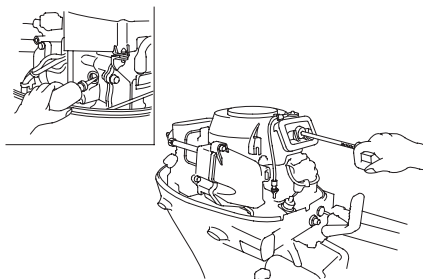

4. Change the engine oil (see page 113). If there was water in the engine crankcase, or if the used engine oil showed signs of water contamination, then a second engine oil change should be performed after running the engine for 1/2 hour.
5. Pour a teaspoon of engine oil into each spark plug hole, then pull the recoil starter grip several times to lubricate the inside of the cylinders. Reinstall the spark plugs.

6. Attempt to start the engine.

▲WARNING

Exposed moving parts can cause injury. Use extreme care when installing the engine cover. Do not operate the outboard motor without the engine cover.

- If the engine fails to start, remove the spark plugs, clean and dry the electrodes, then reinstall the spark plugs and attempt to start the engine again.
 - If the engine starts, and no mechanical damage is evident, continue to run the engine for 1/2 hour or longer (be sure the water level is at least 100 mm (4 in) above the anticavitation plate).
7. As soon as possible, take the outboard motor to a Honda outboard motor dealer for inspection and service.





13. STORAGE

For longer service life of the outboard motor, have your outboard motor serviced by an authorized Honda outboard motor dealer before storage. However, the following procedures can be performed by you, the owner, with a minimum of tools.

Fuel

NOTE:

Gasoline spoils very quickly depending on factors such as light exposure, temperature and time. In worst cases, gasoline can be contaminated within 30 days. Using contaminated gasoline can seriously damage the engine (carburetor clogged, valve stuck). Such damage due to spoiled fuel is disallowed from coverage by the warranty. To avoid this please strictly follow these recommendations:

- Only use specified gasoline (see page 51).
- Use fresh and clean gasoline.
- To slow deterioration, keep gasoline in a certified fuel container.
- If long storage (more than 30 days) is foreseen, drain fuel tank and carburetor.

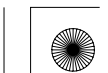

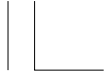

STORAGE

Carburetor Draining

Draining the outboard motor before storing it for a long time.

▲WARNING

Gasoline is extremely flammable, and gasoline vapor can explode, causing serious injury or death. Do not smoke or allow flames or sparks in your working area. KEEP OUT OF REACH OF CHILDREN.

- **Be careful not to spill fuel. Spilled fuel or fuel vapor may ignite. If any fuel is spilled, make sure the area is dry before storing or transporting the outboard motor.**
- **Do not smoke or allow flames or sparks where fuel is drained or stored.**

How to extract the fuel

This procedure requires maintenance skills. Refrain from doing it yourself. Present this manual to your dealer and have the work carried out by them.

NOTE:

Carry out the removal of fuel by following the procedures described in the manual. If you don't follow the procedures correctly, some fuel may remain in the carburetor and starting enrichment system passage causing damage to the engine.

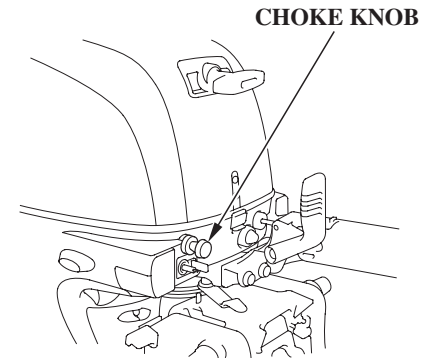

The maintenance procedure differs depending on which enrichment system you have. You can tell which system you have according to whether there is a choke knob.

- With choke knob: Manual starting enrichment system.
- Without the choke knob: Automatic starting enrichment system.





STORAGE

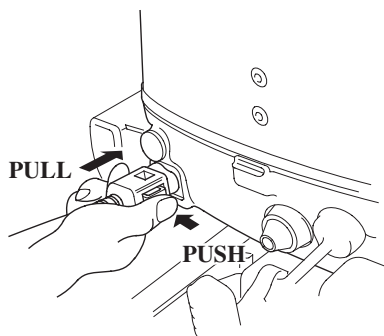

1. Use up all fuel in the fuel supply pipe.
 - (1) Remove the fuel supply hose.
 - (2) Submerge the antiventilation plate.
 - (3) Start the engine and idle the engine until it stops.
 - Tiller handle type (see page 60)
 - Remote control type (see page 66)
 - (4) When using the remote control, turn the engine switch “OFF” after the engine stops.

2. Making it possible to discharge the fuel from the starting enrichment system fuel supply pipe.

- (1) Opening up the starting enrichment system outlet.
 - Without the choke knob:
Wait for an hour or more after the engine stops.
The starting enrichment system opening opens up after about an hour.
- (2) Remove the emergency stop switch clip from the emergency stop switch (see pages 99 and 101).
- (3) Put the shift lever or control lever into the “N” (neutral) position (see pages 61 and 67).

DRAIN SCREW

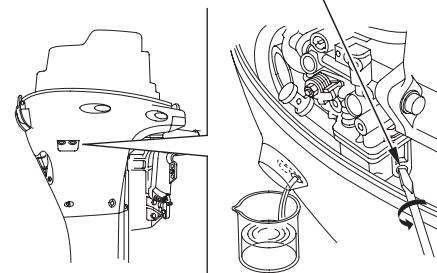

3. Remove fuel from the carburetor float.
 - (1) Remove the engine cover (see page 49).
 - (2) Loosen the drain screw and drain off the fuel into a container.
 - (3) When the fuel has run out, tighten the screw.

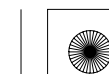



STORAGE

Starting enrichment thermal valve wires

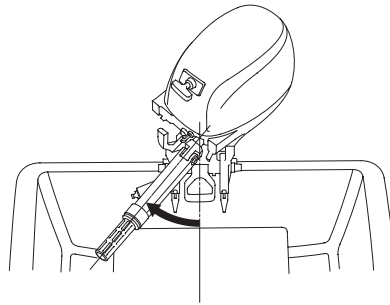
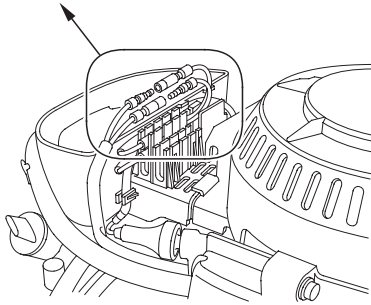

4. Extract the fuel from the starting enrichment system fuel passage.
 - (1) Without the choke knob:
Remove the starting enrichment thermal valve wires.
The fuel passage is opens up.
 - (2) Tilt up the outboard motor 15° – 25°.
 - Manual tilt type (see page 34)
 - Gas assist tilt type (see page 33)
 - Power tilt type (see page 31)
 - (3) Turn the outboard motor all the way to the left.

- (4) Crank the engine by operating the starting mechanism.
 - Starter motor type:
 - ① For the remote control type, turn the engine switch to “ON”.
 - ② Operate the starter motor.
 - Operate for 4 seconds, wait for 10 seconds, then operate again for 4 seconds.
 - The button or engine switch for operating the starter motor varies according to model type (see pages 62 and 68).
 - ③ On the remote control type, turn the engine switch to “OFF”.
 - Recoil starter type:
Pull the recoil starter grip 10 or more times.

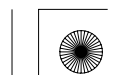
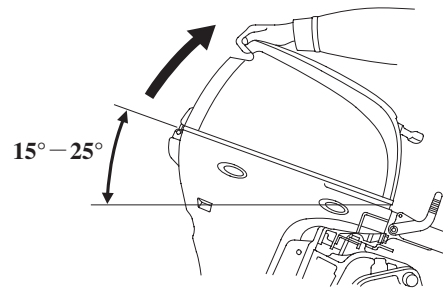



STORAGE

Valve wire installation order

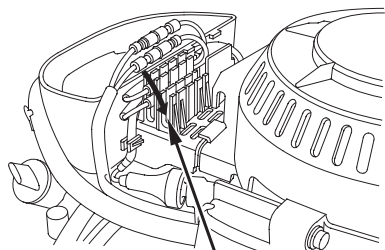

BROWN/WHITE

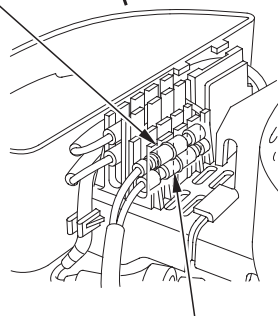

BLACK/GREEN

- (5) Return the starting enrichment system to the way it was before starting the procedure.
- Without the choke knob:
 - ① Reconnect the starting enrichment thermal valve wires securely.

5. Reassemble the removed parts.
- (1) Install the engine cover.
 - (2) Install the emergency stop switch clip to the emergency stop switch (see pages 24 and 28).

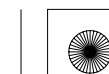



STORAGE

Battery Storage

NOTICE

Battery handling differs according to the type of the battery. Refer to the battery manufacturer's instructions.

▲WARNING

Batteries produce explosive gases: If ignited, an explosion can cause serious injury or blindness. Provide adequate ventilation when charging.

- **CHEMICAL HAZARD:** Battery electrolyte contains sulfuric acid. Contact with eyes or skin, even through clothing, may cause severe burns. Wear a faceshield and protective clothing.

- **Keep flames and sparks away, and do not smoke in the area. ANTIDOTE:** If electrolyte gets into your eyes, flush thoroughly with warm water for at least 15 minutes and call a physician immediately.
- **POISON:** Electrolyte is poison.
ANTIDOTE
 - External: Flush thoroughly with water.
 - Internal: Drink large quantities of water or milk. Follow with milk of magnesia or vegetable oil, and call a physician immediately.
- **KEEP OUT OF REACH OF CHILDREN.**

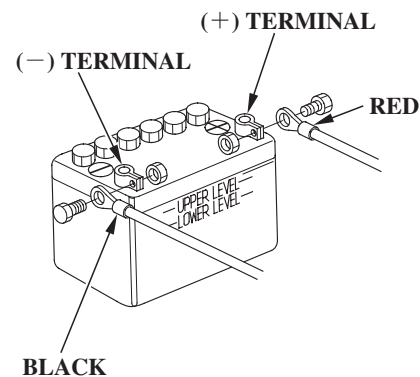

1. Disconnect the battery cable at the battery negative (-) terminal, then at the battery positive (+) terminal.
2. Remove the battery and clean the battery terminals and battery cable terminals with a wire brush or sand paper. Clean the battery with a solution of baking soda and warm water, taking care not to get the solution of water in the battery cells. Dry the battery thoroughly.





STORAGE

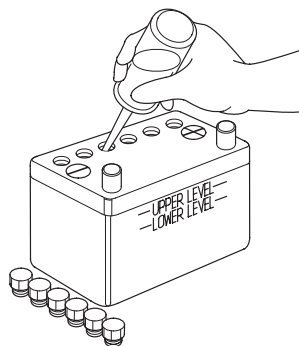

3. Fill the battery with distilled water to the upper level line. Never overfill the battery.
4. Store the battery on a level surface in a cool, dry, well ventilated place out of direct sunlight.
5. Once a month, check the specific gravity of the electrolyte and recharge as required to prolong battery life.

Transport/Storage Position of the Outboard Motor

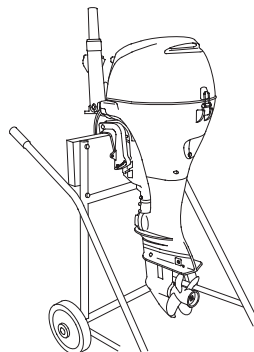

Transport and store the outboard motor either vertically or horizontally, as shown here. Store the outboard motor in a well-ventilated area free from direct sunlight and humidity.

Vertical transport or storage:
Attach the stern bracket to a stand.

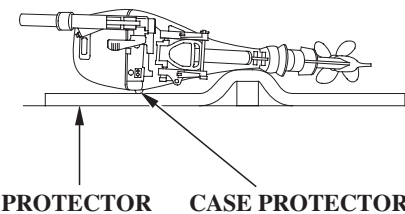

Horizontal transport or storage:
Rest the outboard motor on the case protector.

Always rest the outboard motor on a protector and be sure to protect it from impact and damage.

▲ CAUTION

Any other transport or storage position may cause damage or oil leakage.





14. DISPOSAL

To protect the environment, do not dispose of this product, battery, engine oil, etc. carelessly by leaving them in the waste. Observe the local laws and regulations or consult your authorized Honda dealer for disposal.

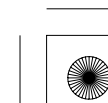
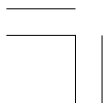



15. TROUBLESHOOTING

〈 Engine fails to start 〉

1. No fuel in tank. → Fill tank with fuel.
2. Fuel line is flattened or kinked. → Check for excessively bent or pinched fuel line.
3. Fuel connector is not connected properly. → Connect properly.
4. Fuel is contaminated or stale. → Replace with new fuel.
5. Battery is discharged. (Electric starter type) → Charge battery.
6. Battery terminal is loose. → Tighten battery terminal.
7. Spark plug cap is loose or disconnected. → Install and tighten spark plug cap securely.
8. Fuse is blown out. (Electric starter type) → Replace with new fuse.
9. Engine is started in wrong procedure. → Start in correct procedure.

〈 Engine speed fluctuates or engine stalls 〉

1. Fuel level is low. → Add fuel.

2. Fuel line is flattened or kinked. → Check for excessively bent or pinched fuel line.
3. Fuel filter is clogged. → Replace fuel filter.
4. Spark plug is fouled. → Remove spark plug and dry and clean it.
5. Spark plug heat range is incorrect. → Replace with spark plug of proper heat range.
6. Spark plug gap is incorrect. → Adjust to proper gap.

〈 Engine speed does not increase 〉

1. Fuel line is flattened or kinked. → Check for excessively bent or pinched fuel line.
2. Fuel filter is clogged. → Replace fuel filter.
3. Engine oil level is low. → Check engine oil and add to specified level.
4. Unmatched propeller is selected. → Consult with an authorized Honda outboard motor dealer.
5. Passengers are not distributed equally. → Distribute the passengers equally.
6. Outboard motor is not installed properly. → Install the outboard motor in the proper position.





TROUBLESHOOTING

〈 Engine overheats 〉

1. Water intake port and/or water check hole are/is clogged. → Clean water intake port and/or water check hole.
2. Engine is overloaded because of unequally distributed passengers or excessive load on the boat. → Distribute the passengers equally. Do not load on the boat excessively.

〈 Engine overrevs 〉

1. Cavitation. → Install the outboard motor in the proper position.
2. Propeller is damaged. → Replace propeller.
3. Unmatched propeller is selected. → Consult with an authorized Honda outboard motor dealer.
4. Trim angle is not correct. → Trim to correct angle.

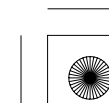
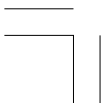



16. SPECIFICATIONS

MODEL		BF8D		
Description Code		BAAJ		
Type		H	HS	R
Overall length		610 mm (24.0 in)		600 mm (23.6 in)
Overall width		345 mm (13.6 in)		
Overall height	S	1,105 mm (43.5 in)		
	L	1,235 mm (48.6 in)		
Transom height (when transom angle at 12°)	S	433 mm (17.0 in)		
	L	563 mm (22.2 in)		
Dry mass (weight) *	S	42.0 kg (92.6 lbs)	45.5 kg (100.3 lbs)	46.0 kg (101.4 lbs)
	L	44.5 kg (98.1 lbs)	48.0 kg (105.8 lbs)	48.5 kg (106.9 lbs)
Rated power		5.9 kW (8.0 PS)		
Full throttle range		4,500 – 5,500 min ⁻¹ (rpm)		
Engine type		4 stroke OHC in-line 2 cylinder, water-cooled		
Displacement		222 cm ³ (13.5 cu-in)		
Spark plug gap		0.8 – 0.9 mm (0.031 – 0.035 in)		
Starter system		Recoil starter	Recoil starter, Electric starter	
Ignition system		C.D.I.		
Lubrication system		Trochoid pump pressure lubrication		
Specified oil		Engine: API standard (SG, SH, SJ) SAE 10W-30 Gear case: API standard (GL-4) SAE 90 Hypoid gear oil		

* Without battery cable, with propeller

Honda outboards are power rated in accordance with ISO8665 (propeller shaft output).

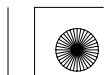



SPECIFICATIONS

Oil capacity	Engine: 1.0 L (1.1 US qt, 0.9 Imp qt) without oil filter change 1.1 L (1.2 US qt, 1.0 Imp qt) with oil filter change Gear case: 0.29 L (0.31 US qt, 0.26 Imp qt)		
D.C. output	12V-6A	12V-12A	12V-12A
Cooling system	Water cooling with thermostat		
Exhaust system	Water exhaust		
Spark plugs	CR5EH-9 (NGK) , U16FER9 (DENSO)		
Fuel pump	Diaphragm type fuel pump		
Fuel	Automotive unleaded gasoline (91 research octane, 86 pump octane, or higher)		
Tank capacity	12 L (3.2 US gal, 2.6 Imp gal)		
Gear change	Forward-Neutral-Reverse (dog type)		
Steering angle	45° right and left		
Transom angle	(Manual tilt type): 5 stages (4°, 8°, 12°, 16°, 20°)		
Tilt angle (when transom angle at 12°)	(Manual tilt SH and LH type): 3-stage adjustment (22°, 37° and 63°) (Manual tilt R type): 3-stage adjustment (22°, 37° and 64°)		
Remote control steering system			Motor-mounted

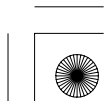
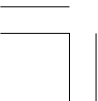



SPECIFICATIONS

MODEL	BF10D		
Description Code	BABJ		
Type	H	HS	R
Overall length	610 mm (24.0 in)		600 mm (23.6 in)
Overall width	345 mm (13.6 in)		
Overall height	S	1,105 mm (43.5 in)	
	L	1,235 mm (48.6 in)	
	X		1,375 mm (54.1 in)
Transom height (when transom angle at 12°)	S	433 mm (17.0 in)	
	L	563 mm (22.2 in)	
	X		703 mm (27.7 in)
Dry mass (weight) *	S	42.0 kg (92.6 lbs)	45.5 kg (100.3 lbs)
	L	44.5 kg (98.1 lbs)	48.0 kg (105.8 lbs)
	X		52.5 kg (115.7 lbs)
Rated power	7.4 kW (10 PS)		
Full throttle range	5,000 – 6,000 min ⁻¹ (rpm)		
Engine type	4 stroke OHC in-line 2 cylinder, water-cooled		
Displacement	222 cm ³ (13.5 cu-in)		
Spark plug gap	0.8 – 0.9 mm (0.031 – 0.035 in)		
Starter system	Recoil starter	Recoil starter, Electric starter	
Ignition system	C.D.I.		
Lubrication system	Trochoid pump pressure lubrication		
Specified oil	Engine: API standard (SG, SH, SJ) SAE 10W-30 Gear case: API standard (GL-4) SAE 90 Hypoid gear oil		

* Without battery cable, with propeller

Honda outboards are power rated in accordance with ISO8665 (propeller shaft output).





SPECIFICATIONS

Oil capacity	Engine: 1.0 L (1.1 US qt, 0.9 Imp qt) without oil filter change 1.1 L (1.2 US qt, 1.0 Imp qt) with oil filter change Gear case: 0.29 L (0.31 US qt, 0.26 Imp qt)		
D.C. output	12V-6A	12V-12A	12V-12A
Cooling system	Water cooling with thermostat		
Exhaust system	Water exhaust		
Spark plugs	CR5EH-9 (NGK) , U16FER9 (DENSO)		
Fuel pump	Diaphragm type fuel pump		
Fuel	Automotive unleaded gasoline (91 research octane, 86 pump octane, or higher)		
Tank capacity	12 L (3.2 US gal, 2.6 Imp gal)		
Gear change	Forward-Neutral-Reverse (dog type)		
Steering angle	45° right and left		
Transom angle	(Manual tilt type): 5 stages (4°, 8°, 12°, 16°, 20°)		
Tilt angle (when transom angle at 12°)	(Manual tilt SH and LH type): 3-stage adjustment (22°, 37° and 63°) (Manual tilt R type): 3-stage adjustment (22°, 37° and 64°)		
Remote control steering system			Motor-mounted

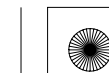



SPECIFICATIONS

MODEL		BF15D				
Description Code		BALJ				
Type		H	HS	HG	R	RT
Overall length		650 mm (25.6 in)			640 mm (25.2 in)	
Overall width		350 mm (13.8 in)				
Overall height	S	1,110 mm (43.7 in)				
	L	1,240 mm (48.8 in)				
	X	_____	_____	_____	_____	1,380 mm (54.3 in)
Transom height (when transom angle at 12°)	S	433 mm (17.0 in)				
	L	563 mm (22.2 in)				
	X	_____	_____	_____	_____	703 mm (27.7 in)
Dry mass (weight) *	S	46.5 kg (102.5 lbs)	49.0 kg (108.0 lbs)	56.0 kg (123.5 lbs)	49.5 kg (109.1 lbs)	57.0 kg (125.7 lbs)
	L	49.5 kg (109.1 lbs)	52.0 kg (114.6 lbs)	57.5 kg (126.8 lbs)	51.0 kg (112.4 lbs)	58.5 kg (129.0 lbs)
	X	_____	_____	_____	_____	61.0 kg (134.5 lbs)
Rated power		11.0 kW (15 PS)				
Full throttle range		4,500 – 5,500 min ⁻¹ (rpm)				
Engine type		4 stroke OHC in-line 2 cylinder, water-cooled				
Displacement		350 cm ³ (21.4 cu-in)				
Spark plug gap		0.8 – 0.9 mm (0.031 – 0.035 in)				
Starter system		Recoil starter	Recoil starter, Electric starter			
Ignition system		C.D.I.				
Lubrication system		Trochoid pump pressure lubrication				
Specified oil		Engine: API standard (SG, SH, SJ) SAE 10W-30 Gear case: API standard (GL-4) SAE 90 Hypoid gear oil				

* Without battery cable, with propeller
Honda outboards are power rated in accordance with ISO8665 (propeller shaft output).





SPECIFICATIONS

Oil capacity	Engine: 1.0 L (1.1 US qt, 0.9 Imp qt) without oil filter change 1.1 L (1.2 US qt, 1.0 Imp qt) with oil filter change Gear case: 0.29 L (0.31 US qt, 0.26 Imp qt)		
D.C. output	12V-6A	12V-12A	12V-12A
Cooling system	Water cooling with thermostat		
Exhaust system	Water exhaust		
Spark plugs	CR5EH-9 (NGK) , U16FER9 (DENSO)		
Fuel pump	Diaphragm type fuel pump		
Fuel	Automotive unleaded gasoline (91 research octane, 86 pump octane, or higher)		
Tank capacity	12 L (3.2 US gal, 2.6 Imp gal)		
Gear change	Forward-Neutral-Reverse (dog type)		
Steering angle	45° right and left		
Transom angle	(Manual tilt type): 5 stages (4°, 8°, 12°, 16°, 20°)		
	(G and T type): 4 stages (8°, 12°, 16°, 20°)		
Tilt angle (when transom angle at 12°)	(Manual tilt SH type): 3-stage adjustment (22°, 37° and 63°)		
	(Manual tilt LH and R type): 3-stage adjustment (22°, 37° and 64°) (G and T type): 64°		
Remote control steering system			Motor-mounted

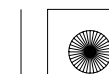

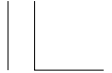

SPECIFICATIONS

MODEL		BF20D					
Description Code		BAMJ					
Type		H	HS	HG	HT	R	RT
Overall length		650 mm (25.6 in)				640 mm (25.2 in)	
Overall width		350 mm (13.8 in)					
Overall height	S	1,110 mm (43.7 in)				1,110 mm (43.7 in)	
	L	1,240 mm (48.8 in)					
	X	—	—	—	—	—	1,380 mm (54.3 in)
Transom height (when transom angle at 12°)	S	433 mm (17.0 in)					
	L	563 mm (22.2 in)					
	X	—	—	—	—	—	703 mm (27.7 in)
Dry mass (weight) *	S	46.5 kg (102.5 lbs)	49.0 kg (108.0 lbs)	56.0 kg (123.5 lbs)	—	49.5 kg (109.1 lbs)	57.0 kg (125.7 lbs)
	L	49.5 kg (109.1 lbs)	52.0 kg (114.6 lbs)	57.5 kg (126.8 lbs)	59.5 kg (131.2 lbs)	51.0 kg (112.4 lbs)	58.5 kg (129.0 lbs)
	X	—	—	—	—	—	61.0 kg (134.5 lbs)
Rated power		14.7 kW (20 PS)					
Full throttle range		5,000 – 6,000 min ⁻¹ (rpm)					
Engine type		4 stroke OHC in-line 2 cylinder, water-cooled					
Displacement		350 cm ³ (21.4 cu-in)					
Spark plug gap		0.8 – 0.9 mm (0.031 – 0.035 in)					
Starter system		Recoil starter	Recoil starter, Electric starter				
Ignition system		C.D.I.					
Lubrication system		Trochoid pump pressure lubrication					
Specified oil		Engine: API standard (SG, SH, SJ) SAE 10W-30 Gear case: API standard (GL-4) SAE 90 Hypoid gear oil					

* Without battery cable, with propeller
Honda outboards are power rated in accordance with ISO8665 (propeller shaft output).

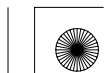



SPECIFICATIONS

Oil capacity	Engine: 1.0 L (1.1 US qt, 0.9 Imp qt) without oil filter change 1.1 L (1.2 US qt, 1.0 Imp qt) with oil filter change Gear case: 0.29 L (0.31 US qt, 0.26 Imp qt)		
D.C. output	12V-6A	12V-12A	12V-12A
Cooling system	Water cooling with thermostat		
Exhaust system	Water exhaust		
Spark plugs	CR5EH-9 (NGK) , U16FER9 (DENSO)		
Fuel pump	Diaphragm type fuel pump		
Fuel	Automotive unleaded gasoline (91 research octane, 86 pump octane, or higher)		
Tank capacity	12 L (3.2 US gal, 2.6 Imp gal)		
Gear change	Forward-Neutral-Reverse (dog type)		
Steering angle	45° right and left		
Transom angle	(Manual tilt type): 5 stages (4°, 8°, 12°, 16°, 20°)		
	(G and T type): 4 stages (8°, 12°, 16°, 20°)		
Tilt angle (when transom angle at 12°)	(Manual tilt SH type): 3-stage adjustment (22°, 37° and 63°)		
	(Manual tilt LH and R type): 3-stage adjustment (22°, 37° and 64°) (G and T type): 64°		
Remote control steering system			Motor-mounted





SPECIFICATIONS

Noise and Vibration

MODEL	BF8D		BF10D	
	T (Tiller handle)	R (Remote control)	T (Tiller handle)	R (Remote control)
Sound Pressure level at operator's ears (2006/42/EC, ICOMIA 39-94)	79 dB (A)	76 dB (A)	80 dB (A)	75 dB (A)
Uncertainty	3 dB (A)	3 dB (A)	3 dB (A)	3 dB (A)
Measured sound power level (Reference to EN ISO3744)	—	—	—	—
Uncertainty	—	—	—	—
Vibration level at hand arm (2006/42/EC, ICOMIA 38-94)	2.7 m/s ²	Not exceed 2.5 m/s ²	3.0 m/s ²	Not exceed 2.5 m/s ²
Uncertainty	1.8 m/s ²	—	1.8 m/s ²	—

MODEL	BF15D		BF20D	
	T (Tiller handle)	R (Remote control)	T (Tiller handle)	R (Remote control)
Sound Pressure level at operator's ears (2006/42/EC, ICOMIA 39-94)	81 dB (A)	77 dB (A)	83 dB (A)	77 dB (A)
Uncertainty	2 dB (A)	2 dB (A)	2 dB (A)	2 dB (A)
Measured sound power level (Reference to EN ISO3744)	87 dB (A)	—	90 dB (A)	—
Uncertainty	2 dB (A)	—	2 dB (A)	—
Vibration level at hand arm (2006/42/EC, ICOMIA 38-94)	3.3 m/s ²	Not exceed 2.5 m/s ²	3.0 m/s ²	Not exceed 2.5 m/s ²
Uncertainty	0.7 m/s ²	—	0.7 m/s ²	—

Reference to: ICOMIA Standard: as it specifies the engine operating conditions and measurement conditions.

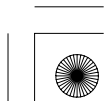
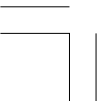



17. MAJOR Honda DISTRIBUTOR ADDRESSES

For further information, please contact Honda Customer Information Centre at the following address or telephone number:

For European

AUSTRIA

Honda Motor Europe (North)
Hondastraße 1
2351 Wiener Neudorf
Tel. : +43 (0)2236 690 0
Fax : +43 (0)2236 690 480
<http://www.honda.at>

BALTIC STATES (Estonia/Latvia/ Lithuania)

Honda Motor Europe Ltd.
Estonian Branch
Tulika 15/17
10613 Tallinn
Tel. : +372 6801 300
Fax : +372 6801 301
✉ honda.baltic@honda-eu.com.

BELGIUM

Honda Motor Europe (North)
Doornveld 180-184
1731 Zellik
Tel. : +32 2620 10 00
Fax : +32 2620 10 01
<http://www.honda.be>
✉ BH_PE@HONDA-EU.COM

BULGARIA

Kirov Ltd.
49 Tsaritsa Yoana Blvd
1324 Sofia
Tel. : +359 2 93 30 892
Fax : +359 2 93 30 814
<http://www.kirov.net>
✉ honda@kirov.net

CROATIA

Fred Bobek d.o.o.
Honda-Marine Croatia - Trg. - Ind.
zona bb
22211 Vodice
Tel. : +385 22 44 33 00/33 10
Fax : +385 22 44 05 00
<http://www.honda-marine.hr>

CYPRUS

Alexander Dimitriou & Sons Ltd.
162, Yiannos Kranidiotis
Avenue
2235 Latsia, Nicosia
Tel. : + 357 22 715 300
Fax : + 357 22 715 400

CZECH REPUBLIC

BG Technik cs, a.s.
U Zavodiste 251/8
15900 Prague 5 - Velka Chuchle
Tel. : +420 2 838 70 850
Fax : +420 2 667 111 45
<http://www.hondamarine.cz>

DENMARK

Tima Products A/S
Tårnfalkevej 16
2650 Hvidovre
Tel. : +45 36 34 25 50
Fax : +45 36 77 16 30
<http://www.tima.dk>

FINLAND

OY Brandt AB
Tuupakantie 7B
01740 Vantaa
Tel. : +358 207757200
Fax : +358 (0)9 878 5276
<http://www.brandt.fi>

FRANCE

Honda Relations Clients
TSA 80627
45146 St Jean de la Ruelle Cedex
Tel. : 02 38 81 33 90
Fax : 02 38 81 33 91
<http://www.honda-fr.com>
✉ espaceclient@honda-eu.com

GERMANY

**Honda Motor Europe (North)
GmbH**
Sprendlinger Landstraße 166
63069 Offenbach am Main
Tel. : +49 69 8309-0
Fax : +49 69 8320 20
<http://www.honda.de>
✉ info@post.honda.de

GREECE

General Automotive Co S.A.
71, Leoforos Athinon
10173 Athens
Tel. : +30 210 3483582
Fax : +30 210 3418092
<http://www.honda.gr>
✉ info@saracakis.gr





MAJOR Honda DISTRIBUTOR ADDRESSES

For further information, please contact Honda Customer Information Centre at the following address or telephone number:

For European (continued)

HUNGARY

Motor Pedo Co., Ltd.
Kamaraerdei ut 3.
2040 Budaors
Tel. : +36 23 444 971
Fax : +36 23 444 972
<http://www.hondakisgepek.hu>
✉ info@hondakisgepek.hu

ICELAND

Bernhard ehf.
Vatnagardar 24-26
104 Reykjavik
Tel. : +354 520 1100
Fax : +354 520 1101
<http://www.honda.is>

IRELAND

Two Wheels Ltd
M50 Business Park, Ballymount
Dublin 12
Tel. : +353 1 4381900
Fax : +353 1 4607851
<http://www.hondaireland.ie>
✉ Service@hondaireland.ie

ITALY

Honda Italia Industriale S.p.A.
Via della Cecchignola, 5/7
00143 Roma
Tel. : +848 846 632
Fax : +39 065 4928 400
<http://www.hondaitalia.com>
✉ info.marine@honda-eu.com

MALTA

Associated Motors Company Ltd.
New Street in San Gwarkin Road -
Mriehel Bypass
Mriehel QRM17
Tel. : +356 21 498 561
Fax : +356 21 480 150

NETHERLANDS

Honda Motor Europe (North)
Afd. Power Equipment-
Capronilaan 1
1119 NN Schiphol-Rijk
Tel. : +31 (0)20 7070000
Fax : +31 (0)20 7070001
<http://www.honda.nl>

NORWAY

AS Kellox
Boks 170 - Nygårdsveien 67
1401 Ski
Tel. : +47 64 97 61 00
Fax : +47 64 97 61 92
<http://www.kellox.no>

POLAND

Aries Power Equipment Sp. z o.o.
ul. Wroclawska 25
01-493 Warszawa
Tel. : +48 (22) 861 43 01
Fax : +48 (22) 861 43 02
<http://www.ariespower.pl>
<http://www.mojahonda.pl>
✉ info@ariespower.pl

PORTUGAL

Honda Portugal S.A.
Rua Fontes Pereira de Melo 16
Abrunheira, 2714-506 Sintra
Tel. : +351 21 915 53 33
Fax : +351 21 915 23 54
<http://www.honda.pt>
✉ honda.produtos@honda-eu.com

REPUBLIC OF BELARUS

Scanlink Ltd.
Kozlova Drive, 9
220037 Minsk
Tel. : +375 172 999090
Fax : +375 172 999900
<http://www.hondapower.by>

RUSSIA

Honda Motor RUS LLC
21. MKAD 47 km., Leninsky district.
Moscow region, 142784 Russia
Tel. : +7 (495) 745 20 80
Fax : +7 (495) 745 20 81
<http://www.honda.co.ru>
✉ postoffice@honda.co.ru

SERBIA & MONTENEGRO

Bazis Grupa d.o.o.
Grcica Milenka 39
11000 Belgrade
Tel. : +381 11 3820 295
Fax : +381 11 3820 296
<http://www.hondasrbija.co.rs>





MAJOR Honda DISTRIBUTOR ADDRESSES

For further information, please contact Honda Customer Information Centre at the following address or telephone number:

For European (continued)

SLOVAK REPUBLIC

Honda Slovakia, s.r.o.
Prievozská 6 821 09 Bratislava
Tel. : +421 2 32131112
Fax : +421 2 32131111
<http://www.honda.sk>

SLOVENIA

AS Domzale Moto Center D.O.O.
Blatnica 3A
1236 Trzin
Tel. : +386 1 562 22 42
Fax : +386 1 562 37 05
<http://www.as-domzale-motoc.si>

SPAIN & Las Palmas province (Canary Islands)

Greens Power Products, S.L.
Poligono Industrial Congost -
Av Ramon Ciurans n°2
08530 La Garriga - Barcelona
Tel. : +34 93 860 50 25
Fax : +34 93 871 81 80
<http://www.hondaencasa.com>

Tenerife province (Canary Islands)

Automocion Canarias S.A.
Carretera General del Sur, KM. 8,8
38107 Santa Cruz de Tenerife
Tél. : + 34 (922) 620 617
Fax : +34 (922) 618 042
<http://www.aucasa.com>
✉ ventas@aucasa.com
✉ taller@aucasa.com

SWEDEN

Honda Nordic AB
Box 50583 - Väst kustvägen 17
20215 Malmö
Tel. : +46 (0)40 600 23 00
Fax : +46 (0)40 600 23 19
<http://www.honda.se>
✉ hpesinfo@honda-eu.com

SWITZERLAND

Honda Suisse S.A.
10 Route des Moulières
1214 Vernier-Genève
Tel. : +41 (0)22 939 09 09
Fax : +41 (0)22 939 09 97
<http://www.honda.ch>

TURKEY

Anadolu Motor Uretim ve Pazarlama AS
Esentepe mah. Anadolu cad. No: 5
Kartal 34870 Istanbul
Tel. : +90 216 389 59 60
Fax : +90 216 353 31 98
<http://www.anadolumotor.com.tr>
✉ antor@antor.com.tr

UKRAINE

Honda Ukraine LLC
101 Volodymyrska Str. - Build. 2
Kyiv 01033
Tel. : +380 44 390 14 14
Fax : +380 44 390 14 10
<http://www.honda.ua>
✉ CR@honda.ua

UNITED KINGDOM

Honda (UK) Power Equipment
470 London Road
Slough - Berkshire, SL3 8QY
Tel. : +44 (0)845 200 8000
<http://www.honda.co.uk>

For Australian

AUSTRALIA

Honda Australia Motorcycle and Power Equipment Pty. Ltd
1954-1956 Hume Highway
Campbellfield Victoria 3061
Tel. : (03) 9270 1111
Fax : (03) 9270 1133
<http://www.hondampe.com.au/>

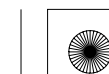



“EC DECLARATION OF CONFORMITY” CONTENT OUTLINE

<p>1) DECLARATION CE DE CONFORMITE 2) LE SOUSSIGNE, (14), REPRESENTANT DU CONSTRUCTEUR, DÉCLARE PAR LA PRESENTE QUE LE PRODUIT EST CONFORME AUX DISPOSITIONS DES DIRECTIVES CE SUIVANTES</p> <p>3) moteur hors-bord, Système de propulsion</p> <p>4) REFERENCE AUX NORMES HARMONISEES 5) DESCRIPTION DE MACHINE 6) CATEGORIE 7) moteur hors-bord 8) MARQUE</p> <p>9) TYPE 10) NUMERO DI SERIE 11) CONSTRUCTEUR 12) REPRESENTANT HABILITE 13) SIGNATURE 14) NOM 15) TITRE</p> <p>16) Directeur Qualite 17) DATE 18) LIEU</p>	français (FRENCH)
<p>1) DICHIARAZIONE DI CONFORMITA' CE 2) IL SOTTOSCRITTO, (14), RAPPRESENTANTE DEL COSTRUTTORE, DICHIARA QUI DI SEGUITO CHE IL PRODOTTO E' CONFORME A QUANTO PREVISTO DALLE SEGUENTI DIRETTIVE COMUNITARIE</p> <p>3) MOTORE FUORIBORDO, Sistema di propulsione</p> <p>4) RIFERIMENTO ALLE NORME ARMONIZZATE 5) DESCRIZIONE DELLA MACCHINA 6) CATEGORIA</p> <p>7) MOTORE FUORIBORDO 8) MARCA 9) TIPO 10) NUMERO DI SERIE 11) FABBRICANTE 12) RAPPRESENTANTE AUTORIZZATO</p> <p>13) FIRMA 14) NOME 15) TITOLO 16) DIRETTORE DELLA QUALITA' 17) ADDI 18) LUOGO</p>	italiano (ITALIAN)
<p>1) EG-KONFORMITÄTSERKLÄRUNG 2) DER UNTERZEICHNER, (14), DER DEN HERSTELLER VERTRITT, ERKLÄRT HIERMIT, DAB DAS PRODUKT IN ÜBEREINSTIMMUNG MIT DEN BESTIMMUNGEN DER NACHSTEHENDEN EG-RICHTLINIEN IST</p> <p>3) Außenbordmotor, Antriebsart</p> <p>4) VERWEIS AUF HARMONISIERTE NORMEN 5) BESCHREIBUNG DER MASCHINE 6) ART 7) Außenbordmotor</p> <p>8) FABRIKAT 9) TYP 10) SERIEN NUMMER 11) HERSTELLER 12) BEVOLLMÄCHTIGTER 13) UNTERSCHIFT 14) NAME 15) TITEL</p> <p>16) Qualitätssi Cherung 17) DATUM 18) ORT</p>	deutsch (GERMAN)
<p>1) EG-VERKLARING VAN OVEREENSTEMMING 2) ONDERGETEKENDE, (14), VERTEGENWOORDIGER VAN DE FABRIKANT, VERKLAART HIERMEE DAT HET PRODUCT VOLDOET AAN DE BEPALINGEN VAN DE VOLGENDE EG-RICHTLIJNEN</p> <p>3) buitenboordmotor, Aandrijfsysteem</p> <p>4) REFERENTIE NAAR GEHARMONISEERDE NORMEN 5) BESCHRIJVING VAN DE MACHINE 6) CATEGORIE</p> <p>7) buitenboordmotor 8) FABRIKAT 9) TYPE 10) SERIEN UMMER 11) FABRIKANT 12) GEMACHTIGDE VAN DE FABRIKANT</p> <p>13) HANDTEKENING 14) NAAM 15) TITEL 16) Directeur Kwaliteitszorg 17) DATUM 18) PLAATS</p>	nederlands (DUTCH)
<p>1) ΕΚ-ΔΗΛΩΣΗ ΕΝΑΡΜΟΝΙΣΗΣ 2) Ο ΥΠΟΓΡΑΦΩΝ, (14), ΕΚΠΡΟΣΩΠΟΝΤΑΣ ΤΟΝ ΚΑΤΑΣΚΕΥΑΣΤΗ, ΔΙΑ ΤΟΥ ΠΑΡΟΝΤΟΣ ΔΗΛΩΝΕΙ ΟΤΙ ΤΟ ΠΡΟΪΟΝ ΒΡΙΣΚΕΤΑΙ ΣΕ ΕΝΑΡΜΟΝΙΣΗ ΜΕ ΤΙΣ ΠΡΟΒΛΕΨΕΙΣ ΤΩΝ ΚΑΤΩΘΙ ΟΔΗΓΙΩΝ ΤΗΣ ΕΕ</p> <p>3) Εξωλέμβια μηχανή, Σύστημα Πρόωσης</p> <p>4) ΠΑΡΑΠΟΜΠΗ ΣΤΑ ΕΝΑΡΜΟΝΙΣΜΕΝΑ ΠΡΟΤΥΠΑ 5) ΠΕΡΙΓΡΑΦΗ ΜΗΧΑΝΗΜΑΤΟΣ 6) ΚΑΤΗΓΟΡΙΑ 7) Εξωλέμβια μηχανή</p> <p>8) ΕΡΓΟΣΤΑΣΙΟ ΚΑΤΑΣΚΕΥΗΣ 9) ΤΥΠΟΣ 10) ΑΡΙΘΜΟΣ ΣΕΙΡΑΣ 11) ΚΑΤΑΣΚΕΥΑΣΤΗΣ 12) ΕΞΟΥΣΙΟΔΟΤΗΜΕΝΟΣ ΑΝΤΙΠΡΟΣΩΠΟΣ</p> <p>13) ΥΠΟΓΡΑΦΗ 14) ΟΝΟΜΑ 15) ΤΙΤΛΟΣ 16) Υπεύθυνος Ποιότητας 17) ΗΜΕΡΟΜΗΝΙΑ 18) ΤΟΠΟΣ</p>	Ελληνικά (GREEK)
<p>1) EF OVERENSSTEMMELSESERKLÆRING 2) UNDERTEGNEDE, (14), DER REPRÆSENTERER FABRIKANTEN, ERKLÆRER HERMED AT PRODUKTET ER I OVERENSSTEMMELSE MED BESTEMMELSERNE I FØLGE EF DIREKTIVERNE</p> <p>3) Utenbordsmotor, Fremdrivningssystem</p> <p>4) REFERENCE TIL HARMONISEREDE STANDARDER 5) BESKRIVELSE AF MASKINEN 6) KATEGORI 7) Utenbordsmotor 8) FABRIKANT</p> <p>9) TYPE 10) SERIEN UMMER 11) FABRIKANT 12) FABRIKANTENS REPRÆSENTANT 13) SIGNATURE 14) NAVN 15) TITEL</p> <p>16) Kvalitets Leder 17) DATO 18) STED</p>	dansk (DANISH)
<p>1) DECLARACIÓN DE CONFORMIDAD 2) EL ABAJO FIRMANTE, (14), EN REPRESENTACIÓN DE FABRICANTE, DECLARA QUE EL PRODUCTO ES CONFORME CON LAS DISPOSICIONES DE LAS SIGUIENTES DIRECTIVAS CE</p> <p>3) Motor fueraborda, Sistema de propulsión</p> <p>4) REFERENCIA A ESTANDARES ARMONIZADOS 5) DESCRIPCIÓN DE LA MAQUINARIA 6) CATEGORÍA 7) Motor fueraborda 8) MARCA</p> <p>9) TIPO 10) NUMERO DE SERIE 11) FABRICANTE 12) REPRESENTANTE AUTORIZADO 13) FIRMA 14) NOMBRE 15) CARGO</p> <p>16) Director de calidad 17) FECHA 18) LUGAR</p>	español (SPANISH)





“EC DECLARATION OF CONFORMITY” CONTENT OUTLINE

<p>1) DECLARAÇÃO CE DE CONFORMIDADE 2) O ABAIXO ASSINADO, (14), EM REPRESENTAÇÃO DO FABRICANTE, PELA PRESENTE DECLARA QUE O PRODUTO ESTÁ EM CONFORMIDADE COM O ESTABELECIDO NAS SEGUINTE DIRECTIVAS COMUNITARIAS 3) Motor fora de borda, Sistema propulsor 4) REFERÊNCIA AS NORMAS HARMONIZADAS 5) DESCRIÇÃO DA MAQUINA 6) CATEGORIA 7) Motor fora de borda 8) MARCA 9) TIPO 10) NUMERO DE SERIE 11) FABRICANTE 12) MANDATARIO AUTORIZADO 13) ASSINATURA 14) NOME 15) TITULO 16) Director de Qualidade 17) DATA 18) LOCAL</p>	português (PORTUGUESE)
<p>1) EY-VAAITIMUSTENMUKAISUUSVAKUUTUS 2) ALLEKIRJOITANUT, (14), JOKA EDUSTAA VALMISTAJAA, VAKUUTTAA TÄTEN, ETTÄ TUOTE ON SEURAAVIEN EU-DIREKTIIVIEN VAAITIMUSTEN MUKAINEN 3) Peramoottori, Työntöjärjestelmä 4) VITTAUS YHTEISIIN STANDARDEIHIN 5) KUVAUUS LAITTEESTA 6) KATEGORIA 7) Peramoottori 8) MERKKI 9) MALLI 10) SARJANUMERO 11) VALMISTAJA 12) VALTUUTETTU EDUSTAJA 13) ALLEKIRJOITUS 14) NIMI 15) TITTELI 16) Laatuspäällikkö 17) PÄIVÄMÄÄRÄ 18) PAIKKA</p>	suomi / suomen kieli (FINNISH)
<p>1) ЕО-ДЕКЛАРАЦИЯ ЗА СЪОТВЕТСТВИЕ 2) ДОЛУ ПОДПИСАЛИЯТ СЕ, (14), ПРЕДСТАВЛЯВАЩ ДИСТРИБУТОРА, ДЕКЛАРИРА, ЧЕ ПРОДУКТА СЪОТВЕТСТВА НА ИЗСКВАНИЯТА НА СЛЕДНИТЕ ЕВРОПЕЙСКИ ДИРЕКТИВИ 3) ИЗВЪН БОРДОВИ ДВИГАТЕЛ, Задвижваща система 4) СЪОТВЕТСТВИЕ С ХАРМОНИЗИРАНИТЕ СТАНДАРТИ 5) ОПИСАНИЕ НА АРТИКУЛА 6) КАТЕГОРИЯ 7) ИЗВЪНБОРДОВИ ДВИГАТЕЛ 8) МАРКА 9) ТИП 10) СЕРИЕН НОМЕР 11) ПРОИЗВОДИТЕЛ 12) ОТОРИЗИРАН ПРЕСТАВИТЕЛ 13) ПОДПИС 14) ИМЕ 15) ТИТЛА 16) МЕНИДЖЪР НА КАЧЕСТВОТО 17) ДАТА 18) МЯСТО</p>	български (BULGARIAN)
<p>1) EG-FÖRSÄKRAN OM ÖVERENSSTÄMMELSE 2) UNDERTECKNAD, (14), REPRESENTERANDE TILLVERKARE, FÖRSÄKRAR HÄRMED ATT PRODUKTEN ÖVERENSSTÄMMER MED BESTÄMMELSERNA I FÖLJANDE EG-DIREKTIVE 3) Utomboromotor, Framdrivningssystem 4) REFERERANDE TILL HARMONISERADE STANDARDER 5) BESKRIVNING AV UTRUSTNINGEN 6) KATEGORI 7) Utomboromotor 8) MERKKI 9) TYPBETECKNING 10) SERIENUMER 11) TILLVERKARE 12) REPRESENTERANDE TILLVERKARENS 13) SIGNATUR 14) NAMN 15) TITEL 16) Kvalitetschef 17) DATUM 18) ORT</p>	svenska (SWEDISH)
<p>1) DEKLARACJA ZGODNOSCI WE 2) NIŻEJ PODPISANY, (14), REPREZENTUJĄCY PRODUCENTA, DEKLARUJE Z CAŁĄ ODPOWIEDZIALNOŚCIĄ, ŻE PRODUKT SPEŁNIA WYMAGANIA ZAWARTE W NASTĘPUJĄCYCH DYREKTYWACH UNIJNYCH 3) Silnik zaburtowy, Układ napędowy 4) ZASTOSOWANE NORMY ZHARMONIZOWANE 5) OPIS URZĄDZENIA 6) KATEGORIA 7) Silnik zaburtowy 8) MARKA 9) TYP 10) NUMERY SERYJNE 11) PRODUCENT 12) UPOWAŻNIONY PRZEDSTAWICIEL PRODUCENTA 13) PODPIS 14) NAZWISKO 15) TYTUŁ 16) Menadżer Jakości 17) DATA 18) MIEJSCE</p>	polski (POLISH)
<p>1) MEGFELELŐSÉGI NYILATKOZAT 2) ALULÍROTT, (14), MINT A GYÁRTÓ KÉPVISELŐJE NYILATKOZIK, HOGY AZ ALÁBBI TERMÉK MINDENBEN MEGFELEL A KÖVETKEZŐ EC ELOÍRÁSOK RENDELKEZÉSEINEK: 98/37/EC, 89/336/EEC-93/68/EC: 3) KÜLSŐ CSONAKMOTOR, Hajtás rendszer 4) ÖSSZHANGBAN A KÖV. SZABVANYOKKAL 5) A GÉP LEÍRÁSA 6) KATEGÓRIA 7) KÜLSŐ CSONAKMOTOR 8) GYÁRTOTTA 9) TÍPUS 10) SORSZÁM 11) GYÁRTÓ 12) ENGEDÉLLEL RENDELKEZŐ KÉPVISELŐ 13) ALÁÍRÁS 14) NÉV 15) BEOSZTAS 16) MINŐSÉGI IGAZGATO 17) KELTEZÉS DATUMA 18) KELTEZÉS HELYE</p>	magyar (HUNGARIAN)
<p>1) Prohlášení o shodě 2) ZASTUPCE VÝROBCE, (14), SVÝM PODPÍSEM POTVRZUJE, ŽE DANY VÝROBEK JE V SOULADU S NÁSLEDUJÍCÍMI SMĚRNICEMI A NORMAMI EVROPSKEHO SPOLEČENSTVÍ: 3) ZÁVĚSNÝ LODNÍ MOTOR, Pohonný systém 4) ODKAZ NA HARMONIZOVANÉ NORMY: 5) POPIS VÝROBKU 6) KATEGORIE: 7) ZÁVĚSNÝ LODNÍ MOTOR 8) ZNAČKA: 9) TYP: 10) VÝROBNÍ ČÍSLO: 11) VÝROBCE: 12) AUTORIZOVANÝ ZASTUPCE: 13) PODPIS: 14) JMENO: 15) POZICE 16) Manažer kvality 17) DATUM: 18) MÍSTO:</p>	čeština (CZECH)





“EC DECLARATION OF CONFORMITY” CONTENT OUTLINE

<p>1) ES VYHLÁSENIE O ZHODE 2) DOLUPODPÍSANÝ, (14), ZASTUPUJÚCI VÝROBCU, TÝMTO DEKLARUJE, ŽE PRODUKT JE V SÚLADE S USTANOVENIAMÍ NASLEDOVNÝCH SMERNÍC ES</p> <p>3) ZÁVESNÝ LODNÝ MOTOR, Systém pohonu</p> <p>4) REFERENCIA K HARMONIZOVANÝM ŠTANDARDOM 5) IDENTIFIKÁCIA STROJOV</p> <p>6) KATEGÓRIA 7) ZÁVESNÝ LODNÝ MOTOR 8) VÝROBCA/ZNAČKA 9) TYP 10) SÉRIOVÉ ČÍSLO</p> <p>11) VÝROBCA 12) AUTORIZOVANÝ ZÁSTUPCA 13) PODPIS 14) MENO 15) POZÍCIA 16) MANAŽÉR KVALITY 17) DÁTUM</p> <p>18) MIESTO</p>	slovenčina (SLOVAK)
<p>1) EF SAMSVARSÆRKLERING 2) UNDERTEGNEDE, (14), SOM REPRÆSENTERER FABRIKANTEN, ERKLÆRER HERVED AT PRODUKTET ER I OVERENSSTEMMELSE MED BESTEMMELSENE I FØLGENDE EU DIREKTIV</p> <p>3) Utenbordsmotor, Fremdrifts system</p> <p>4) REFERANSER TIL HARMONISERED E STANDARDE R 5) BESKRIVELSE AV MASKINEN 6) KATEGORI 7) Utenbordsmotor 8) FABRIKANT 9) TYPE 10) SERIE NUMMER 11) FABRIKANT 12) FABRIKANTENS REPRESENTANT 13) SIGNATUR 14) NAVN</p> <p>15) TITTEL 16) Kvalitetssjef 17) DATO 18) STED</p>	norsk (NORWEGIAN)
<p>1) DECLARATIE DE CONFORMITATE. 2) SUBSEMNATUL, (14), REPREZENTAND PE PRODUCATOR, DECLAR PRIN PREZE NTA CA PRODUSUL ESTE IN CONFORMITATE CU PREVEDERILE URMATOARELOR DIRECTIVE CE</p> <p>3) MOTOR IN AFARA BORDULUI (EXTERN), Sistem de propulsie</p> <p>4) REFERIRE LA STANDARDELE ARMONIZATE: 5) DESCRIEREA ECHIPAMENTULUI 6) CATEGORIA: 7) MOTOR EXTERN</p> <p>8) MARCA 9) TIPUL 10) NUMAR DE SERIE 11) PRODUCATOR 12) REPRESENTANT AUTORIZAT 13) SEMNATURA 14) NUME</p> <p>15) TITLUL 16) DIRECTOR DE CALITATE 17) DATA 18) LOCATIE</p>	română (ROMANIAN)
<p>1) EU VASTAVUSDEKLARATSIOON 2) ALLAKIRJUTANU, P. RENNEBOOG, ESINDADES TOOTJAT, DEKLAREERIB SINKOHAL, ET TOODE ON VASTAVUSES JÄRGMISTE EC DIREKTIIVIDE SÄTETEGA</p> <p>3) Pardavāline mootor, Tõukursüsteem</p> <p>4) VIIDE ÜHTLUSTATUD</p> <p>STANDARDITELE: 5) MEHĦANISMI KIRJELDUS 6) KATEGOORIA: 7) pardavāline mootor 8) VALMISTAJA: 9) TŪŪP: 10) SEERIANUMBER: 11) TOOTJA: 12) VOLITATUD ESINDAJA: 13) ALLKIRI: 14) NIMI: 15) AMET 16) Kvaliteedijuht 17) KUUPÄEV: 18) KOHT:</p>	estli (ESTONIAN)
<p>1) EK ATBILSTĪBAS DEKLARĀCIJA 2) ZEMĀK MINĒTĀS, (14), KĀ RAŽOTĀJA PĀRSTĀVIS AR ŠO APSTĪPRINA, KĀ ŠIS PRODUKTS PILNĪBĀ ATBILST VĪSIEM STANDARTIEM, KĀS ATRUNĀTI SEKOJOŠAJĀS EC-DIREKTĪVĀS</p> <p>3) Piekarināmais laivas dzinējs, Virzošā spēka sistēma</p> <p>4) Apsaucoties uz saskaņotajiem standartiem 5) Iekārtas apraksts 6) Kategorija 7) Piekarināmais laivas motors</p> <p>8) Preču zīme 9) Tips 10) Sērijas numurs 11) Izgatavotājs 12) Autorizētais pārstāvis 13) Paraksts 14) Vārds, Uzvārds 15) Tituls</p> <p>16) Kvalitātes vadītājs 17) Datums 18) Vieta</p>	latviešu (LATVIAN)
<p>1. EB ATITIKTIES DEKLARACIJA 2. ZEMIAUI PASIRASES, (14), ATSTOVAUJANTIS GAMINTOJA DEKLARUOJA KAD PRODUKTAS ATITINKA REIKALAVIMUS PAGAL ŠIAS EB DIREKTYVAS.</p> <p>3. PAKABINAMAS VARIKLIS, Varomasis būdas</p> <p>4. NUORODA Į HARMONIZUOTUS STANDARTUS. 5. MAŠINOS APRAŠYMAS. 6. KATEGORIJA. 7. Pakabinamas variklis. 8. MARKĖ.</p> <p>9. TIPAS 10. SERIJINIS NUMERIS. 11. GAMINTOJAS. 12. AUTORIZUOTAS ATSTOVAS. 13. PARAŠAS. 14. V. PAVARDĖ</p> <p>15. PAREIGOS 16. KOKYBĖS VADYBININKAS. 17. DATA. 18. VIETA</p>	lietuvių kalba (LITHUANIAN)
<p>1) ES-DEKLARACIJA O USTREZNOSTI 2) PODPISANI, (14), PREDSTAVNIK PROIZVAJALCA, IZJAVLJAM DA IZDELKI USTREZAJO NASLEDNJIM DEKLARACIJAM</p> <p>3) Izvenkrmni motorji, Pogonski sistem</p> <p>4) SKLADNOST Z NASLEDNJIMI STANDARDI 5) OPIS IZDELKOV</p> <p>6) KATEGORIJA 7) Izvenkrmni motorji 8) PROIZVAJA 9) TIP 10) SERIJSKA ŠTEVILKA 11) PROIZVAJALEC 12) POOBLAŠČEN PREDSTAVNIK 13) PODPIS 14) IME 15) FUNKCIJA 16) Direktor presoje 17) DATUM 18) KRAJ</p>	slovenščina (SLOVENIAN)





“EC DECLARATION OF CONFORMITY” CONTENT OUTLINE

1) EB-YFIRLÝSING 2) UNDIRRITAÐUR HR. ,(14), LÝSI YFIR FYRIR HÖND FRAMLEIÐANDA AÐ VARAN UPPFYLLIR EFTIRFARANDI EC-TILSKIPANIR 3) Utanborðsmótorar, knúningsafl kerfi 4) TILVÍSUN UM HEILDARSTAÐAL 5) LÝSING Á VÉLBÚNAÐI 6) FLOKKUR 7) Utanborðsmótorar 8) FRAMLEIÐSLA 9) GERÐ 10) SERÍAL NÚMER 11) FRAMLEIÐANDI 12) LÖGGILDIR AÐILAR 13) UNDIRSKRIFT 14) NAFN 15) TITILL 16) Skráningarstjóri 17) DAGSETNING 18) STAÐUR Íslenska (ICELANDIC)
1) AT UYGUNLUK BEYANI 2) AŞAĞIDA İMZASI BULUNAN VE İMALATÇININ YETKİLİ TEMSİLCİSİ OLAN ,(14), ÜRÜNÜN ŞU AT YÖNETMELİKLERİNİN HÜKÜMLERİNE UYGUN OLDUĞUNU BEYAN EDER. 3) Dıştan takma motor, tahrik sistemi 4) UYUMLAŞTIRILMIŞ STANDARTLARA ATIF 5) MAKİNANIN TARİFİ 6) KATEGORİ 7) Dıştan takma motor 8) MARKA 9) TİP 10) SERİ NUMARASI 11) İMALATÇI 12) YETKİLİ TEMSİLCİ 13) İMZA 14) ADI 15) ÜNVANI 16) Homologasyon Yöneticisi 17) TARİH 18) YER Türk (TURKISH)
1)EK-IZJAVA O SUKLADNOSTI 2)POTPISANI P.RENNEBOOG, PREDSTAVNIK PROIZVOĐAČA, IZJAVLJUJE DA JE PROIZVOD U SUKLADNOSTI S ODREDBAMA SLJEDEĆEG EK PROPISA 3)Vanbrodski motor, Pogonski sustav 4)REFERENCA NA USKLAĐENE NORME 5)OPIS STROJA 6)KATEGORIJA 7)Vanbrodski motor 8)IZRADIO 9)TIP 10)SERIJSKI BROJ 11)PROIZVOĐAČ 12)OVLAŠTENI PREDSTAVNIK 13)POTPIS 14)IME 15)TITULA 16)Upravitelj homologacije 17)DATUM 18)MJESTO hrvatski (CROATIAN)

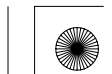



19. INDEX

Anode Metal	34	EMISSION CONTROL SYSTEM	
Battery		(for Bodensee-Lake type)	125
Charging DC Receptacle.....	47	Engine	
Connections.....	46	Cover Latch.....	36
Electrolyte Level	53	Oil	
Service.....	118	Change.....	113
Storage.....	135	Level.....	50
Break-in Procedure.....	79	Protection System.....	94
Carburetor Draining	131	Start Button	22
Choke Knob.....	23	Stop Switch	24
Friction (Manual choke type).....	126	Switch.....	27
Cleaning and Flushing	107	Fast Idle Lever.....	29
Component Identification	17	Fuel	
Controls	22	Filler Cap Vent Knob/Fuel Gauge	38
Cooling Water Intake Port	35	Filter Check/Replacement.....	121
Cruising		Level.....	51
(H type).....	80	Line	
(R type).....	83	Connection	58
Cruising in Shallows	98	Connector	39
Disposal.....	137	Removal	102
“EC DECLARATION OF CONFORMITY”		Storage.....	130
Content Outline	152	Tank and Tank Filter Cleaning	124
Emergency		Tank and Vent Knob	57
Starting	71		
Stop Switch Lanyard			
(H type)	24		
(R type).....	28		





INDEX

Gasoline Containing Alcohol.....	52	Outboard Motor	
Gear		Angle	43
Oil Check/Change	115	Attachment	41
Shifting		Overheat Warning	
(H type)	79	Light/Buzzer.....	30
(R type).....	82	Power Tilt Switch.....	31
High Altitude Operation.....	98	Pre-Operation Checks	49
Installation	40	Propeller and Cotter Pin	54
Height	41	Propeller Change.....	127
Location.....	40	Remote Control	
Lubrication	120	Installation.....	48
Maintenance	109	Lever.....	26
Schedule	111	Friction	55
Major Honda Distributor Addresses	149	Removing/Installing Engine Cover	49
Manual Relief Valve	32, 91	Replacing the Fuse	127
Moorage		Safety.....	10
(G type).....	89	Information.....	10
(T type).....	92	Label Locations	13
Mooring.....	93	Servicing a Submerged Outboard Motor	128
Neutral Release Lever	27	Shift Lever.....	22
Oil Pressure Indicator		Spark Plug Service	116
Light	25	Specifications	140
Light/Buzzer.....	29	Starter Grip	22
Operation	79	Starting the Engine	57
(H type).....	79	(H type).....	60
(R type).....	82	(R type).....	66
Other Checks	56	Steering.....	80

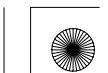



INDEX

Steering Handle Friction	55	Water Check Hole	35
Stopping the Engine	99	Wiring Diagram	Inside back cover
(H type).....	99	With Water Hose Joint (Optional part)	107
(R type).....	101	Without Water Hose Joint.....	108
Storage.....	130		
Position of the Outboard Motor.....	136		
Tachometer (optional equipment).....	30		
Throttle			
Friction Dial	24		
Grip.....	23		
Tilt			
Lever			
(G type)	33		
(Manual tilt type).....	34		
Lock Lever	34		
Tilting the Outboard Motor			
(Common)	84		
(Manual tilt type).....	85		
(G type).....	87		
(T type).....	90		
Tool Kit and Spare Parts	110		
Trailing	106		
Transom Angle Adjusting Rod	37		
Transom Height.....	40		
Transporting	102		
Troubleshooting	138		
Starting Problems	78		

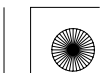



11/09/06 11:24:35 32ZY0620_160

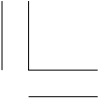

MEMO



160

